



BASHKIA FIER

DREJTORIA E PROJEKTEVE TË INFRASTRUKTURËS

**KRYETAR I BASHKISË
ARMANDO SUBASHI**



PROJEKT ZBATIMI

**OBJEKTI : RIKONSTRUKSIONI I RRUGES QENDER
DARZEZE - BREGDETJE(LINDJE E PERNDIM)**

PLANIMETRIA E PERGJITHSHME E RIKONSTRUKSIONIT TE SEGMENTIT TE RRUGES
NGA QENDRA DARZEZE DERI NE BREGDET
(ANA PERENDIMORE) SH 1:2000

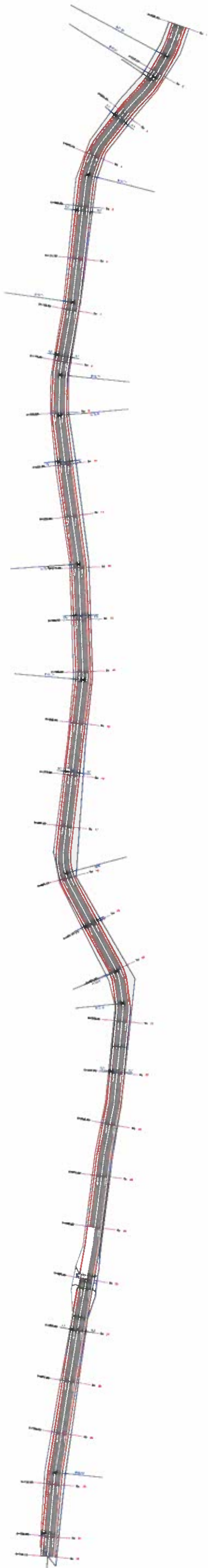

		RIKONSTRUKSIONI RRUGES		FLETA	
NGA QENDRA DARZEZE - BREGDET (NE PERENDIM)				A-01	
ORGANI I TITULLI E PROFESIONALITETI		Ing.	Haxhi Avdullai	REPUBLICA E ALBANISE	
PROJ. KONSTRUKTOR		Ing.	Haxhi Avdullai	MINISTRI E BEGJEVE DHE TRANSPORTIT	
PROJ. ARKITEKTONIK		Ark.	Enid TAVANXHIU	BASHKIA E FIER	
TOPOGRAF		G.J.	Istodor PRIFTI	BASHKIA E FIER	
PROJEKTI				DHELETOR 2024	
PROJEKTI				BASHKIA E FIER	

**PLANIMETRIA E PERGJITTHSHEME E RIKONSTRUKSIONIT TE SEGMENTIT TE RRUGES
NGA QENDRA DARZEZE DERI NE BREGDET
(ANA PERENDIMORE) SH 1:500**

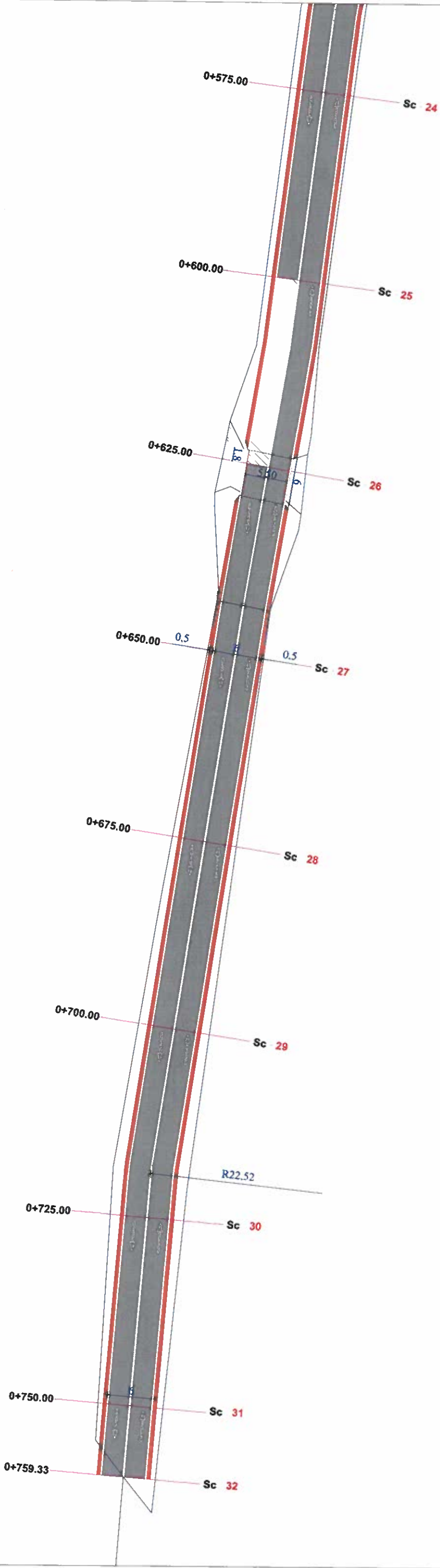

		RIKONSTRUKSIONI RRUGES NGA QENDRA DARZEZE – BREGDET (NE PERENDIM)	
		FLETA A-02	
PROJEKTUESI SH. PERSONALITETI TË VETËDITËS	Ing.	Hasbi Avdullai	PLANI I PERGJITSHEM
PROJ. ARKITEKTONIK	Ark.	Erald TAVANXHIU	DHJETOR 2024
TOPOGRAF	G.J.	Isidor PRILETI	BASHKIA FIER (QARKU FIER)
PRAKSITI			BASHKIA FIER

PLANIMETRIA E PERGJITHSHME E RIKONSTRUKSIONIT TE SEGMENTIT TE RRUGES
 NGA QENDRA DARZEZE DERI NE BREGDET
 (ANA PERENDIMORE) SH 1:500

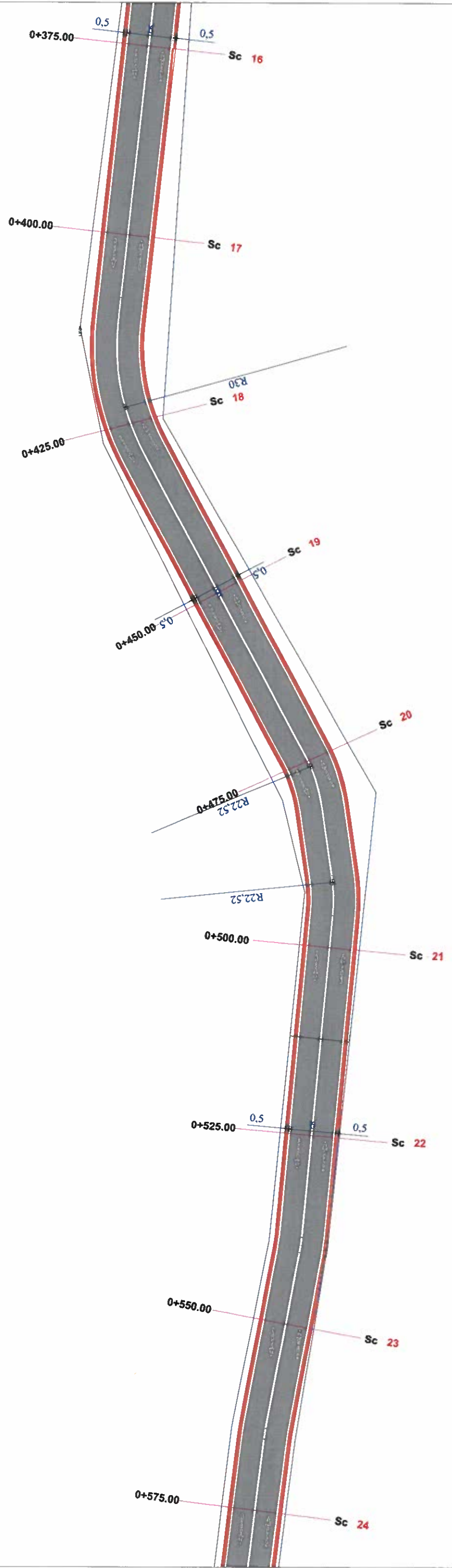

		RIKONSTRUKSIONI RRUGES NGA QENDRA DARZEZE - BREGDET (NE PERENDIM)		FLETA A-03	
INZHINIERI I PËRPLASIMIT Prou Konstruktior	Ing. Haxhi Avdullai	INZHINIERI I PROJEKTIMIT Prou Arkitekturorik	Ark. Endri TAVANXHIU	PLANI I PERGJITHSEM	DH. LATOR 2024
TOROGRAF POKOSITI	G.J. Isidor PRIFTI	Bashkia FIER(QARKU FIER) SHKIPË		BASHKIA FIER	



PLANIMETRIA E PERGJITHSHME E RIKONSTRUKSIONIT TE SEGMENTIT TE RRUGES
 NGA QENDRA DARZEZE DERI NE BREGDET
 (ANA PERENDIMORE) SH 1:500

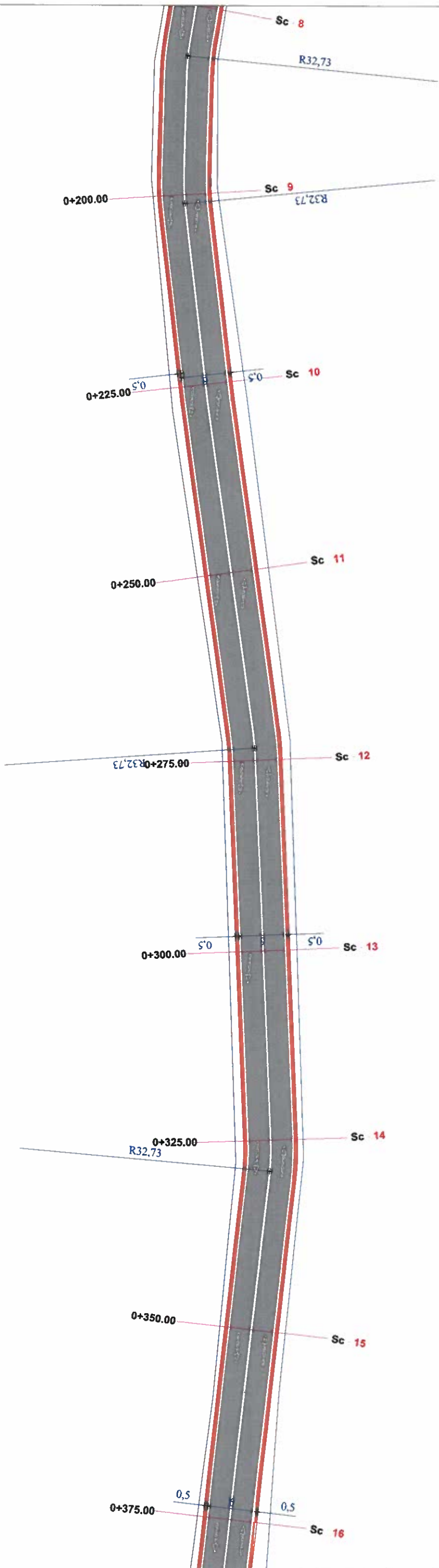

		RIKONSTRUKSIONI RRUGES NGA QENDRA DARZEZE - BREGDET (NE PERENDIM)		FLETA A-04	
INSTITUCIONI QARKOR PROI KONSTRUKTOR	Ing. Piroi Konstruktior	Haxhi Avdullahi	Haxhi Avdullahi	PLANI I PERGJITHSEM	
PROJEKTI TOPOGRAFI	Ark. G.J.	Isidor PRIFTI	Isidor PRIFTI	DHJETOR 2024	
PAKOSITI			Bashkia FIER(QARKU FIER)		
PAKOSITI			BASHKIA FIER		

PLANIMETRIA E PERGJITHSHME E RIKONSTRUKSIONIT TE SEGMENTIT TE RRUGES
 NGA QENDRA DARZEZE DERI NE BREGDET
 (ANA PERENDIMORE) SH 1:500

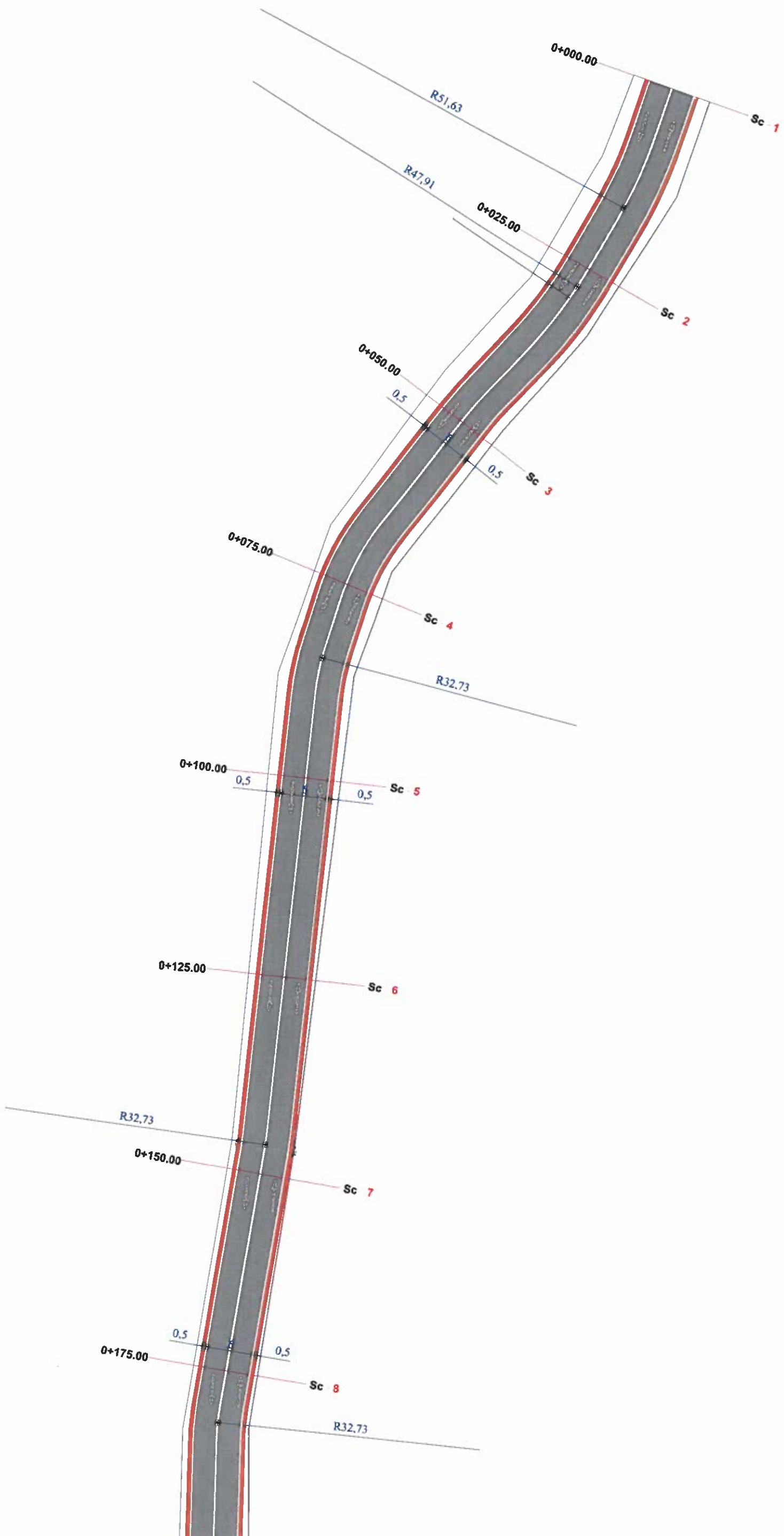

		RIKONSTRUKSIONI RRUGES NGA QENDRA DARZEZE - BREGDET (NE PERENDIM)		FLETA A-05	
ING. HAKBI AVDULLAI	ING. HAKBI AVDULLAI	ING. ENALD TAVANXHIU	ING. ENALD TAVANXHIU	PLANI I PERGJITHSHM	DHJETOR 2024
PPOJ. KONSTRUKTOR	PPOJ. KONSTRUKTOR	PPOJ. KONSTRUKTOR	PPOJ. KONSTRUKTOR	BASHKIA FIERQARKU FIER	BASHKIA FIER
PPOJ. ARKITEKTONIK	PPOJ. ARKITEKTONIK	PPOJ. ARKITEKTONIK	PPOJ. ARKITEKTONIK	BASHKIA FIERQARKU FIER	BASHKIA FIER
TOPOGRAF	TOPOGRAF	TOPOGRAF	TOPOGRAF	BASHKIA FIERQARKU FIER	BASHKIA FIER
PERKOSITI	PERKOSITI	PERKOSITI	PERKOSITI	BASHKIA FIERQARKU FIER	BASHKIA FIER

PLANIMETRIA E PERGJITHSHME E RIKONSTRUKSIONIT TE SEGMENTIT TE RRUGES
NGA QENDRA DARZEZE DERI NE BREGDET
(ANA LINORE) SH 1:2500

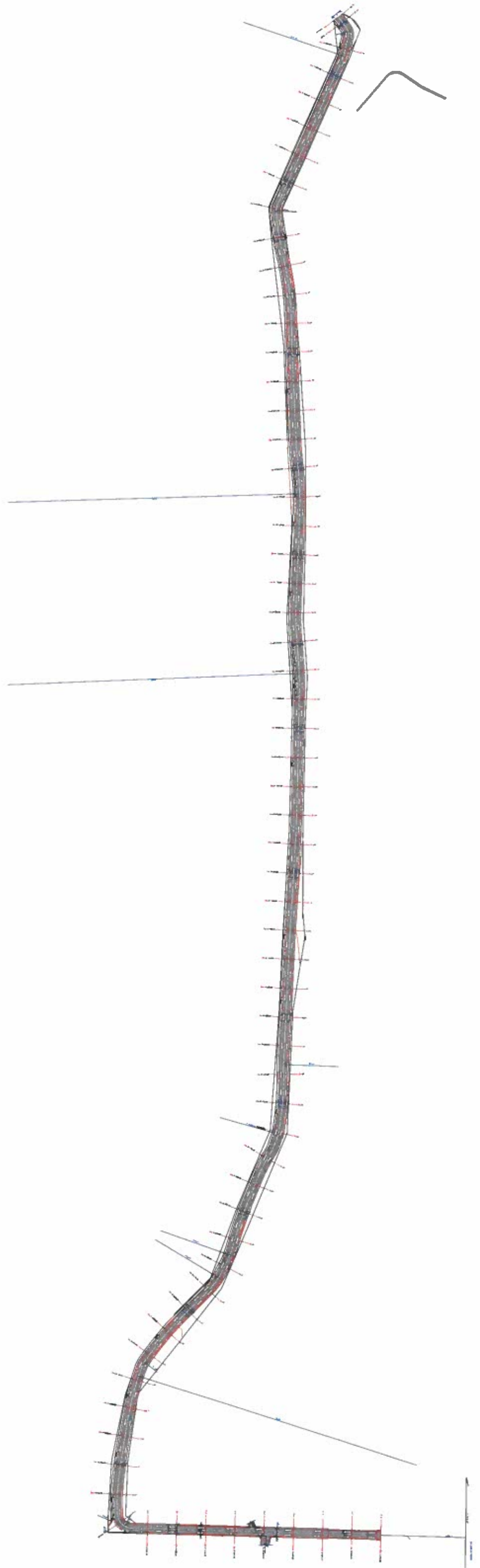

		RIKONSTRUKSIONI RRUGES		FLETA	
NGA QENDRA DARZEZE - BREGDETE (NE LINDJE)				A-01	
PROJEKTUESI	ING.	HAKBI AVDULLAI	PROJEKTUESI	PLANI I PERGJITHSHEM	
PAZI KONSTRUKTOR	ING.	HAKBI AVDULLAI	PAZI	DH.ETOR 2024	
PROJ. ARKITEKTONIK	ARK.	ERLID TAVANXHIU	PROJ. ARKITEKTONIK	BASHKIA FIER(QARINJER)	
TOPOGRAFI	G.J.	ISIDOR PRIFTI	TOPOGRAFI	BASHKIA FIER	
PRUKOSTI			PRUKOSTI		

PLANIMETRIA E PERGJITHSHME E RIKONSTRUKSIONIT TE SEGMENTIT TE RRUGES
 NGA QENDRA DARZEZE DERI NE BREGDET
 (ANA LINORE) SH 1:500

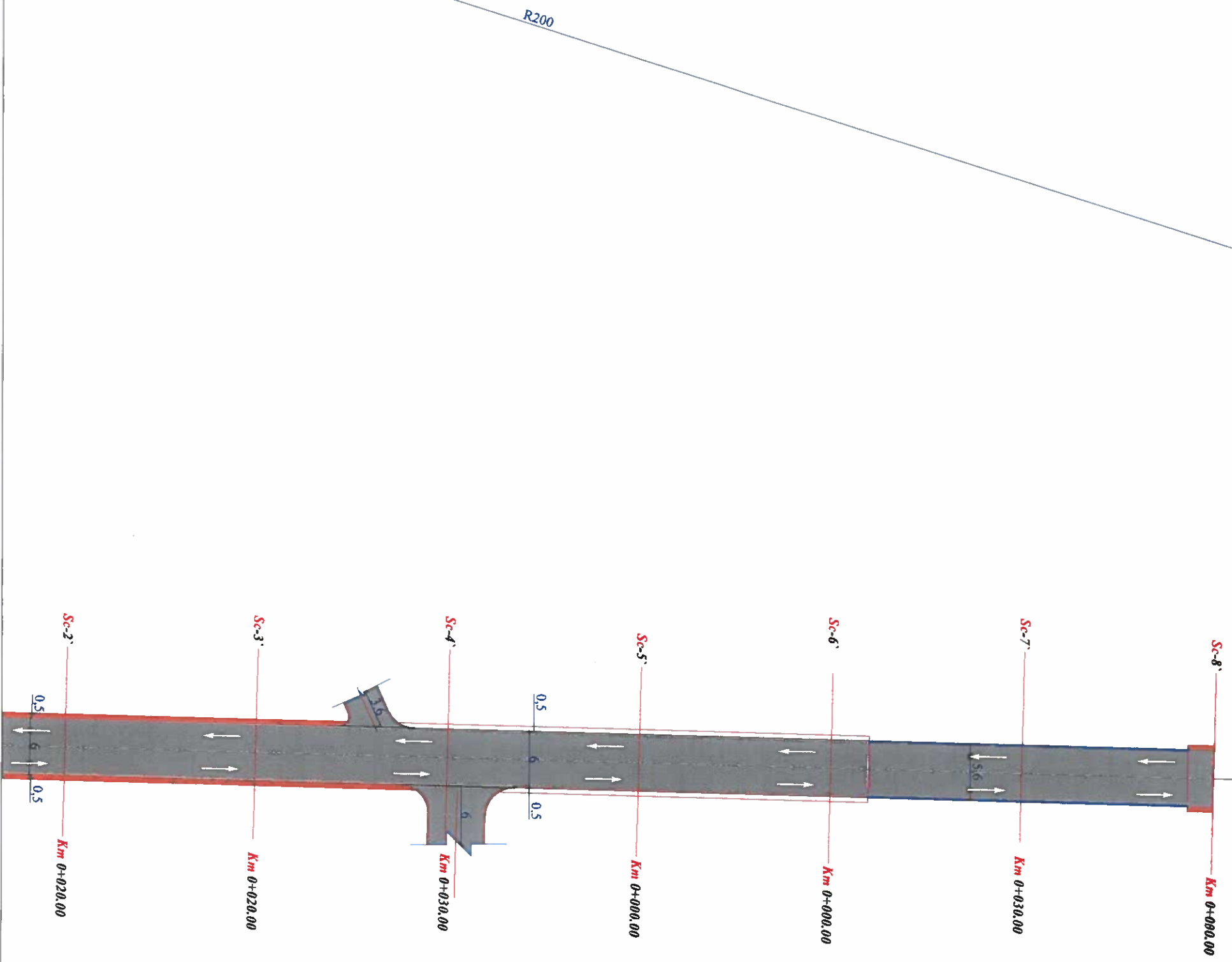

		RIKONSTRUKSIONI RRUGES NGA QENDRA DARZEZE - BREGDETE (NE LINDJE)		FLETA A-02	
INSTITUTI QENKORRATSE PUNA PUNETORISE	Ing. Pno Konstruktior	Ing. Haxhi Avdullahi	Ark. Enid TAVANXHIU	G.J. Isidor PRIFTI	BASHKIA FIER(QARKU NER)
PEOI ARKITEKTONIK	TOPOGRAFI	POKRISTI	BASHKIA FIER(QARKU NER)	DHALETOR 2024	BASHKIA FIER



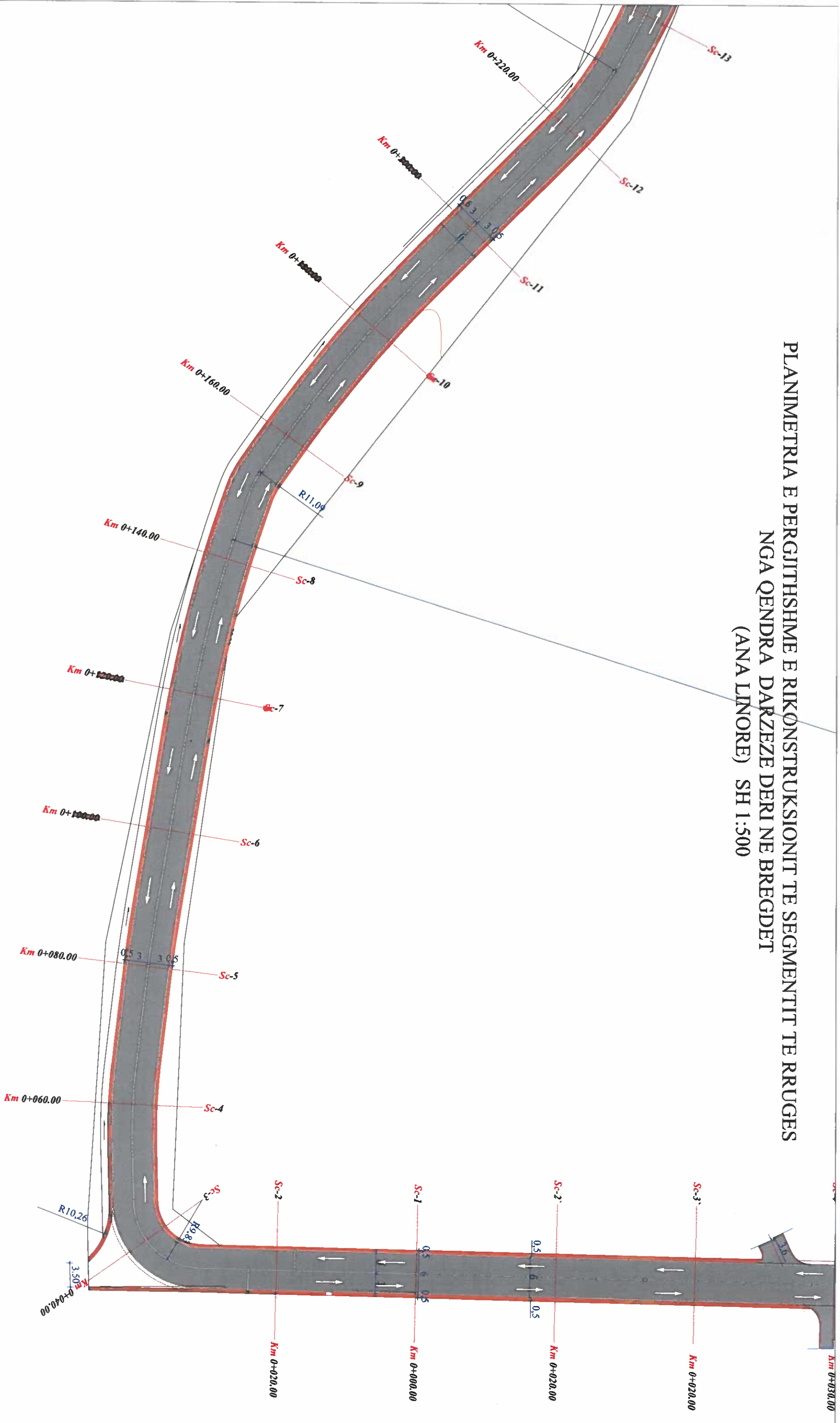

PLANIMETRIA E PERGJITHSHME E RIKONSTRUKSIONIT TE SEGMENTIT TE RRUGES
 NGA QENDRA DARZEZE DERI NE BREGDET
 (ANA LINORE) SH 1:500

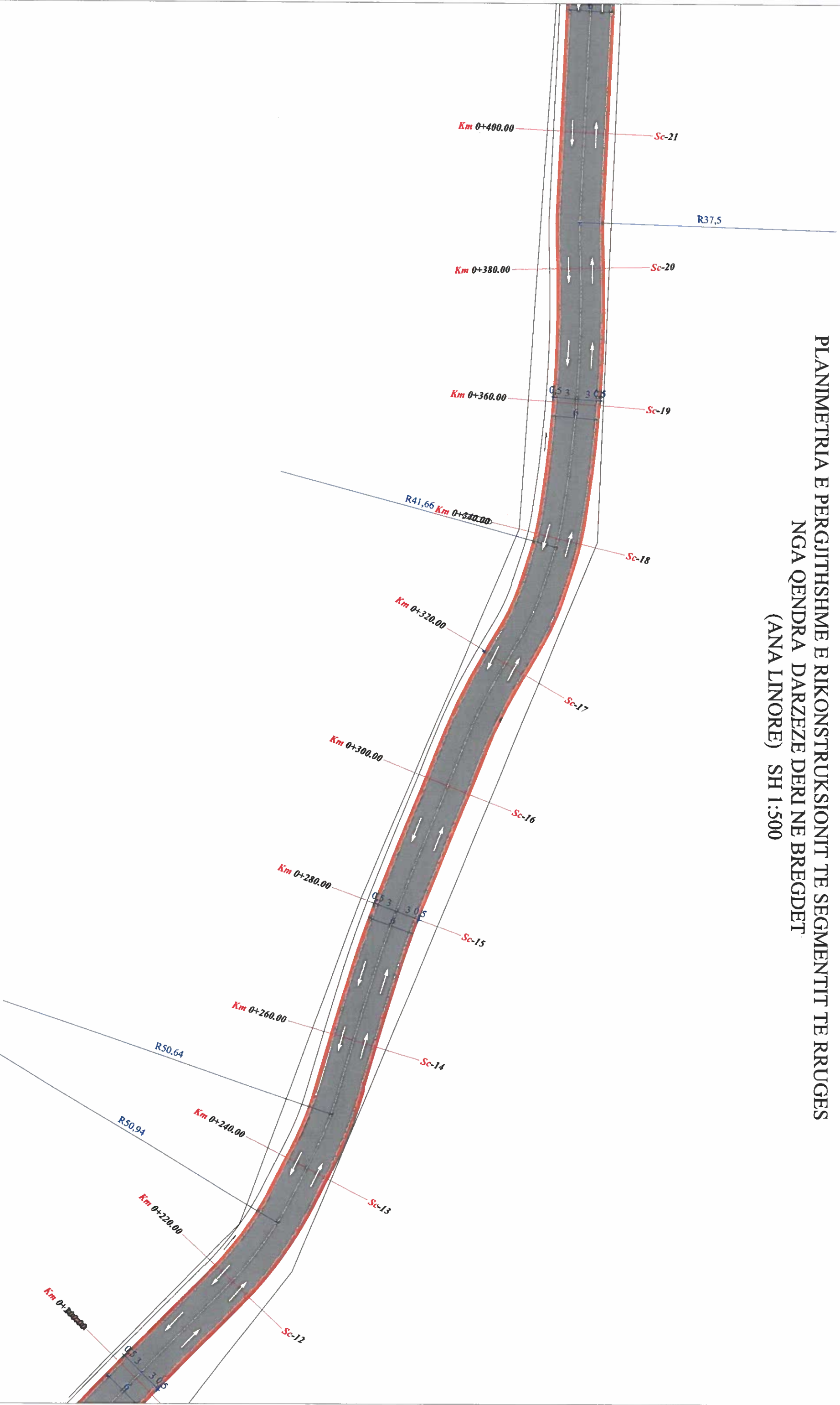

		RIKONSTRUKSIONI RRUGES NGA QENDRA DARZEZE - BREGDET (NE LINDJE)	
INSHALUESHTE E PROJEKTIUT NE PERDALIMIN E PUNES Proj. Konstruktor	Ing. Haxhi Avdullai	FLETA A-03	BASHKIA FIER
Proj. ARKITEKTONIK	Ark. Enal TAVANXIHU	DHAKTOR 2024	BASHKIA FIER
TOPOGRAFI	GJ. Istider PRIFTI	BASHKIA FIER (QARKU FIER)	BASHKIA FIER
POKRISITI	BASHKIA FIER (QARKU FIER)	BASHKIA FIER	BASHKIA FIER

PLANIMETRIA E PERGJITHSHME E RIKONSTRUKSIONIT TE SEGMENTIT TE RRUGES
 NGA QENDRA DARZEZE DERI NE BREGDET
 (ANA LINORE) SH 1:500



		RIKONSTRUKSIONI RRUGES NGA QENDRA DARZEZE - BREGDET (NE LINDJE)		FLETA A-04	
INZHENERI I PROJEKTIMIT P. AVDULLAJ	INZHENERI I PROJEKTIMIT P. AVDULLAJ	INGJ. HAXHI AVDULLAJ	INGJ. HAXHI AVDULLAJ	ARK. ERDIT TAVANXIHU	ARK. ERDIT TAVANXIHU
TOPOGRAFI P. AVDULLAJ	TOPOGRAFI P. AVDULLAJ	G.J. HESDOR PRIFTI	G.J. HESDOR PRIFTI	DHEKTOR 2024	DHEKTOR 2024
POKOSITI BASHKIA FIER(QARKU FIER)			BASHKIA FIER		

PLANIMETRIA E PËRGJITHSHME E RIKONSTRUKSIONIT TË SEGMENTIT TË RRUGES
 NGA QENDRA DARZEZE DER NE BREGDET
 (ANA LINORE) SH 1:500

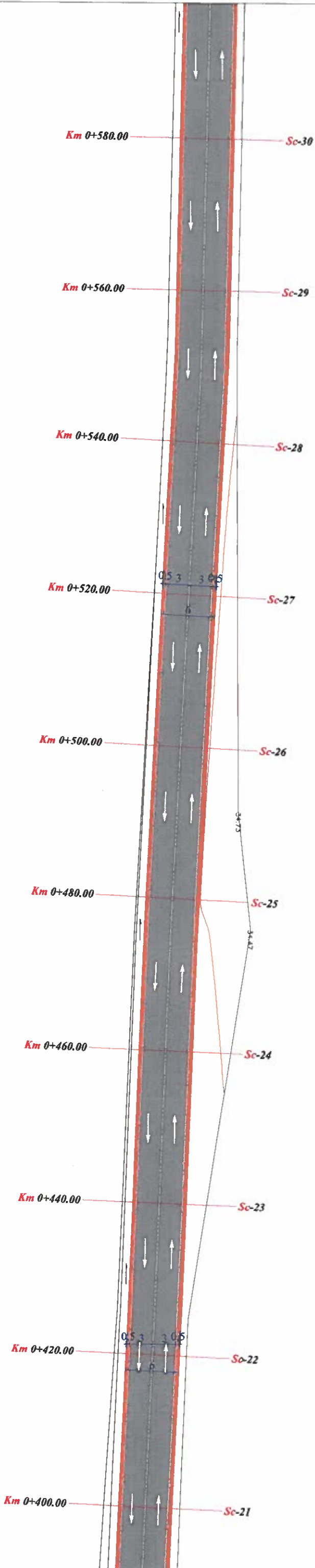

 <p>MINISTRI E INFRASTRUKTURËS DHE TRANSPORTIT REPUBLIKË E ALBANIË</p>		RIKONSTRUKSIONI RRUGES		FLETA	
		NGA QENDRA DARZEZE - BREGDET (NE LINDJE)		A-05	
PROJ. KONSTRUKTOR	ING.	Haxhi Avdullai	PROJ. ARKITEKTONIK	ARK.	Haxhi Avdullai
PROJ. TOPOGRAFI	G.J.	Istidar PRIFTI	PROJ. PERGJITHSHEM	DHJETOR 2024	BASHKIA FIER
Bashkia FIER(QARKU FIER)			BASHKIA FIER		

PLANIMETRIA E PERGJITHSHME E RIKONSTRUKSIONIT TE SEGMENTIT TE RRUGES
 NGA QENDRA DARZEZE DERI NE BREGDET
 (ANA LINORE) SH 1:500

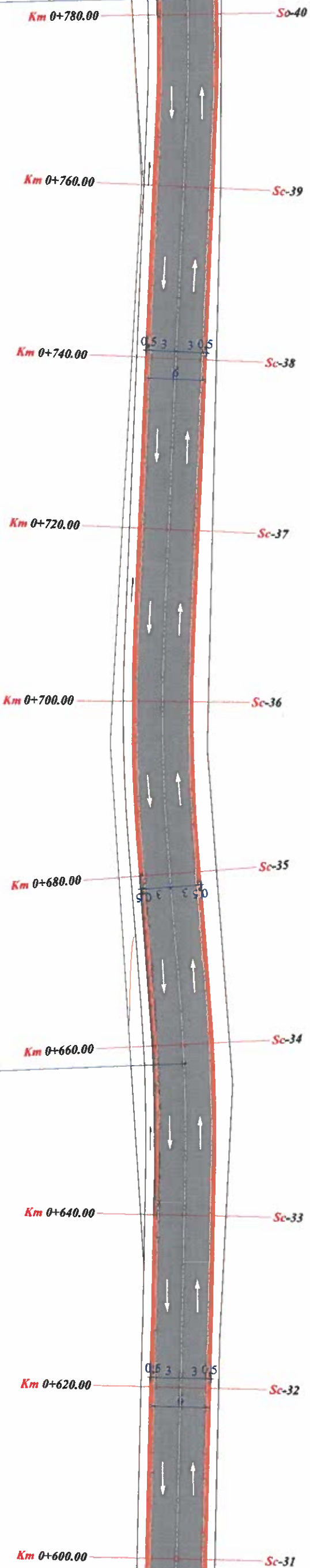

		RIKONSTRUKSIONI RRUGES NGA QENDRA DARZEZE - BREGDET (NE LINDJE) (NE LINDJE)		FLETA A-06	
		Inj. Haxhi Avdullahi	Inj. Haxhi Avdullahi	Ark. Endri TAVANXHIU	G.J. Isidor PRIFTI
Proi Konstruktor	Proi Ashtrektorik	Topograf	Porositi	DHEKTOR 2024	BASHKIA FIER

PLANIMETRIA E PERGJITHSHME E RIKONSTRUKSIONIT TE SEGMENTIT TE RRUGES
 NGA QENDRA DARZEZE DERI NE BREGDET
 (ANA LINORE) SH 1:500

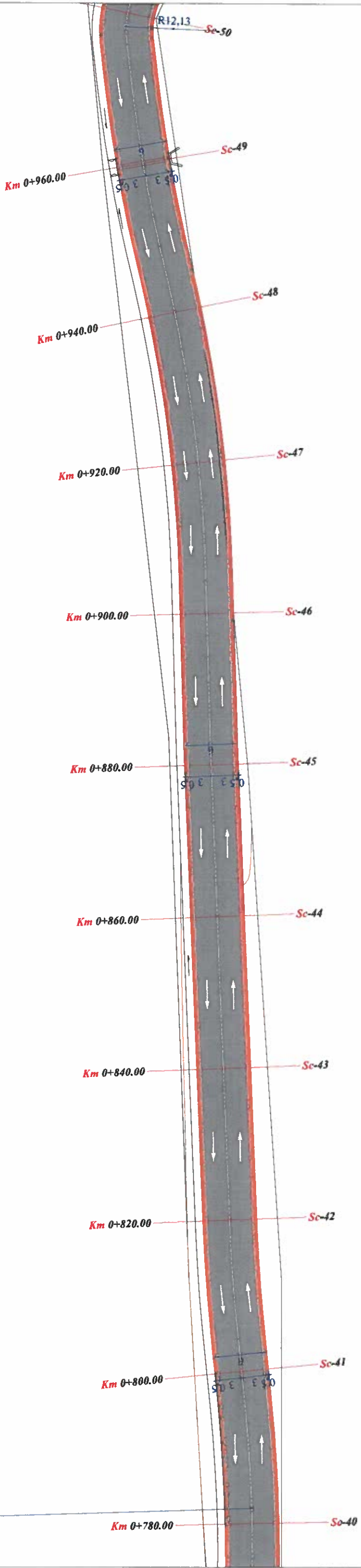

		RIKONSTRUKSIONI RRUGES NGA QENDRA DARZEZE - BREGDET (NE LINDJE)		FLETA A-07	
INSHIPTI PERSHETURIA E RIKONSTRUKSIONIT P. Prof. Konstruktor Prof. ARKITEKTURORIK TOPOGRAF POKRISITI	Ing. Haxhi Avdullai Ing. Haxhi Avdullai Ark. Enal TAVANXHIU G.J. Iisidor PRIFTI	Bashkia FIER(QARKU FIER)	Bashkia FIER(QARKU FIER)	DHEKTOR 2024 BASHKIA FIER	BASHKIA FIER

PLANIMETRIA E PERGJITHSHME E RIKONSTRUKSIONIT TE SEGMENTIT TE RRUGES
 NGA QENDRA DARZEZE DERI NE BREGDET
 (ANA LINORE) SH 1:500

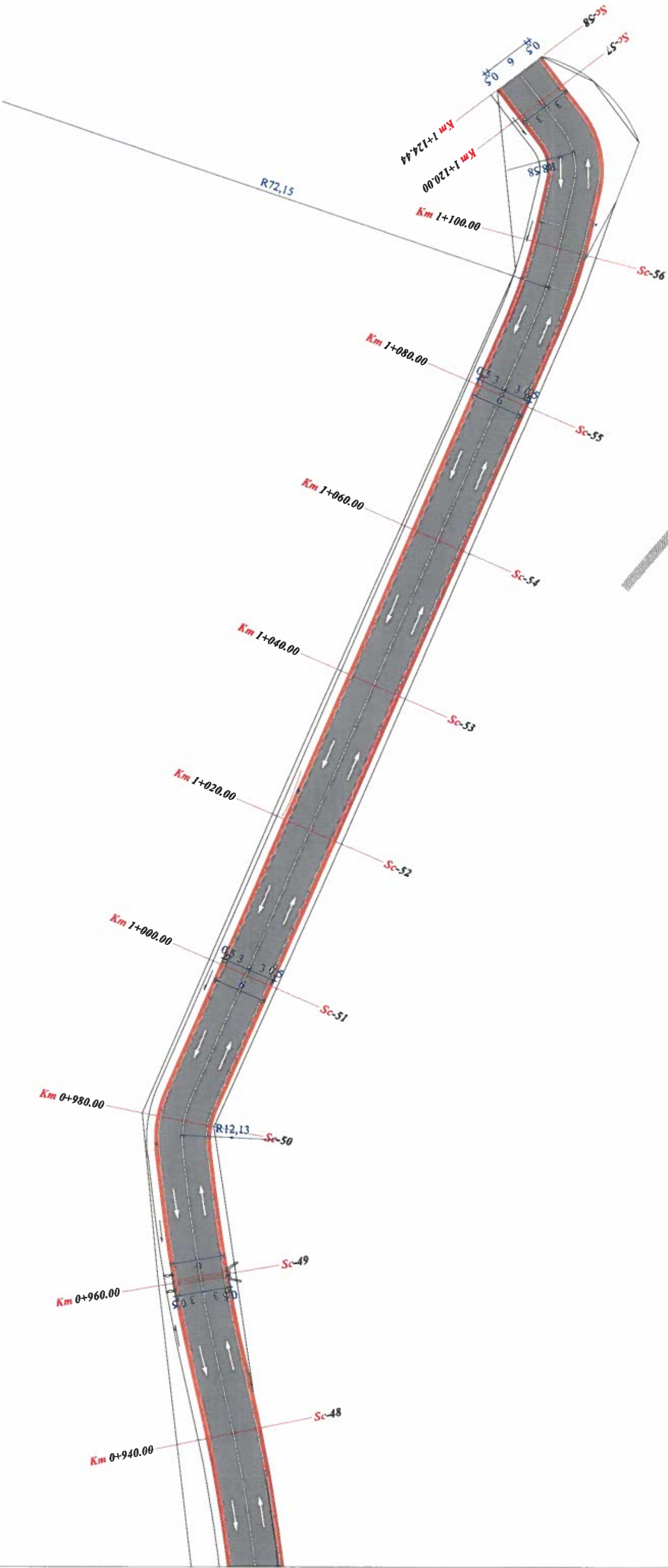

		RIKONSTRUKSIONI RRUGES NGA QENDRA DARZEZE - BREGDET (NE LINDJE)		FLETA A-08	
INSHALIMETI I PROJEKTIUT HYDRAULIKETI	Ing. Proi. Konstruktor	Ing. Haxhi Avdullai	Ing. Proi. Arkitekturorik	Ark. Enal TAVANXHIU	PLANI I PERGJITHSEM
TOKORRAF	G.J. PIRKOSITI	Inzh.	G.J. PIRKOSITI	Inzh.	DHEKTOR 2024
Bashkia FIERQARKU FIERR				BASHKIA FIER	





**RIKONSTRUKSIONI I RRUGES QENDER DARRZEZE - BREGDET
(NE LINDJE E PERNDIM)**

HOROGRAFIA



		RIKONSTRUKSIONI RRUGES NGA QENDRA DARRZEZE - BREGDETE (NE LINDJE E PERNDIM)		FLETA K-01	
<small>DEPARTAMENTI SHI PROJEKTOVIT I INFRASTRUKTURAS</small>	<small>Ing.</small>	Haxhi Avdullai			
<small>Proj. Konstruktor</small>	<small>Ing.</small>	Haxhi Avdullai			OROGRAFIA
<small>Proj. ARKITEKTONIK</small>	<small>Ark.</small>	Erald TAVANXHIU			
<small>TOPOGRAFI</small>	<small>Gj.</small>	Isidor PRIFTI			SHKURT 2025
<small>POROSITI</small>		Bashkia FIER(QARKU FIER)			BASHKIA FIER



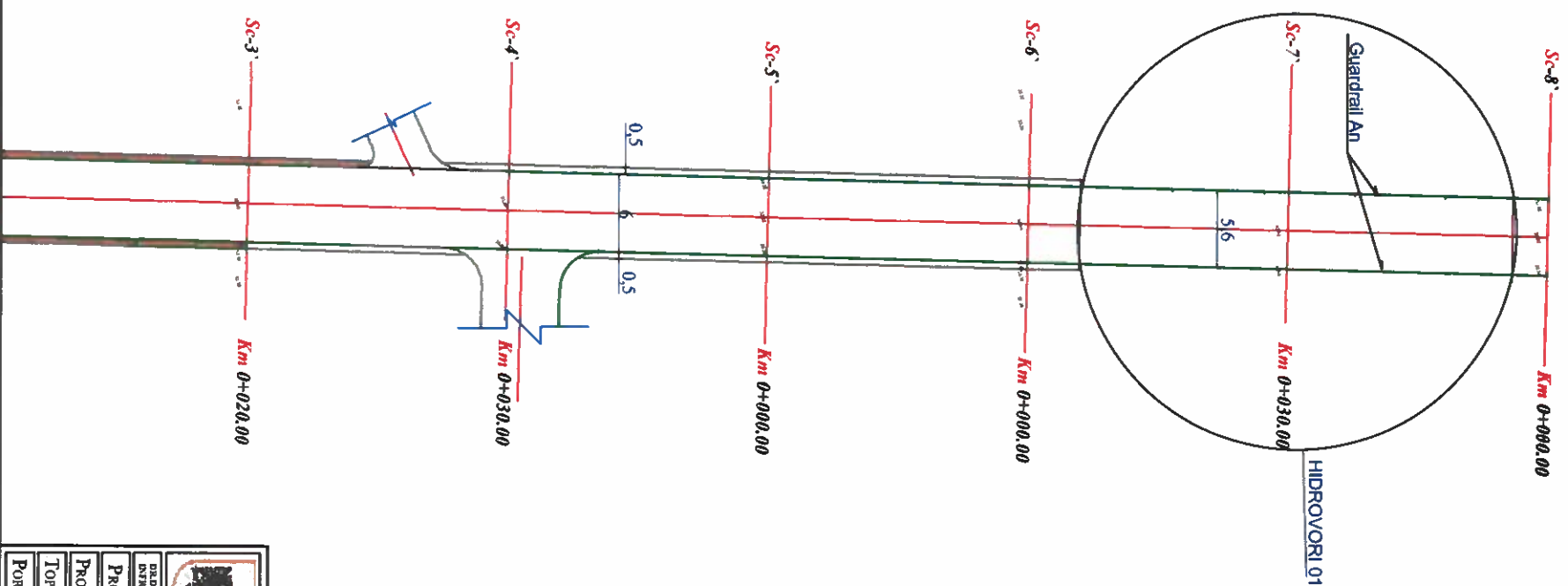

TOPOGRAFIJA E RIKONSTRUKSIONIT TE SEGMENTIT TE RRUGES
 NGA QENDRA DARZEZE DERI NE BREGDET(ANA LINDORE) SH 1:500



		RIKONSTRUKSIONI RRUGES NGA QENDRA DARZEZE - BREGDETE (NE LINDJE)		FLETA K-02	
				TOPOGRAFIJA PLANIMETRIA Plik.08 - 03* DHJETOR 2024	
DR. DOKUMENTIMIS SE PROJEKTES DHE DIMENSIONIMIT KRES		Ing.	Haxhi Avdullai	Bashkia FIER(QARKU FIER) (SHIKI)	
Proj. Konstruktor		Ing.	Haxhi Avdullai	BASHKIA FIER	
Proj. ARKITEKTONIK		Ark.	Erald TAVANXHIU	BASHKIA FIER	
TOPOGRAF		G.J.	Ilisidor PRIFTI	BASHKIA FIER	
POROSITI		Bashkia FIER(QARKU FIER)		BASHKIA FIER	

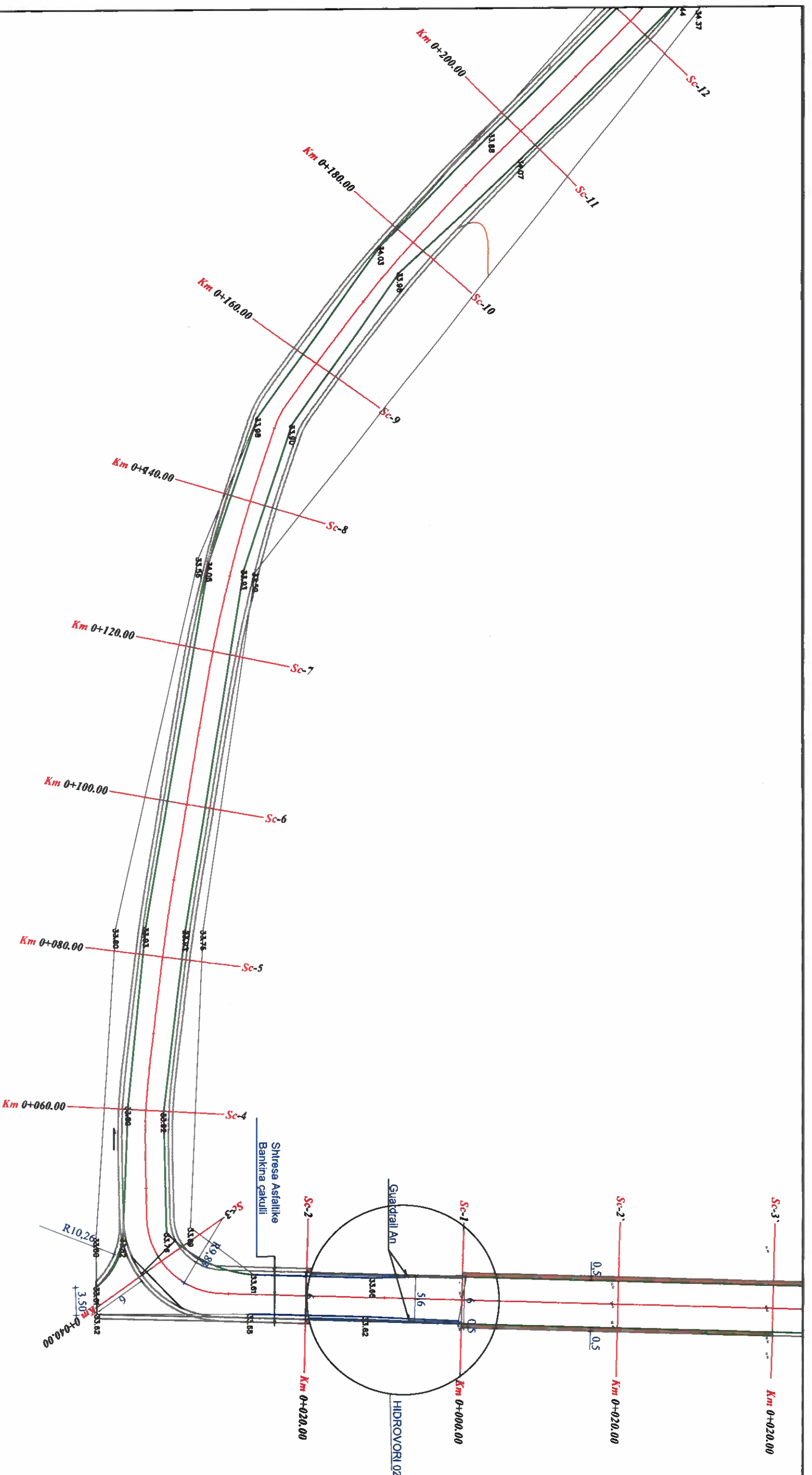

TOPOGRAFIA E RIKONSTRUKSIONIT TE SEGMENTIT TE RRUGES
 NGA QENDRA DARZEZE DERI NE BREGDET(ANA LINDORE) SH 1:500

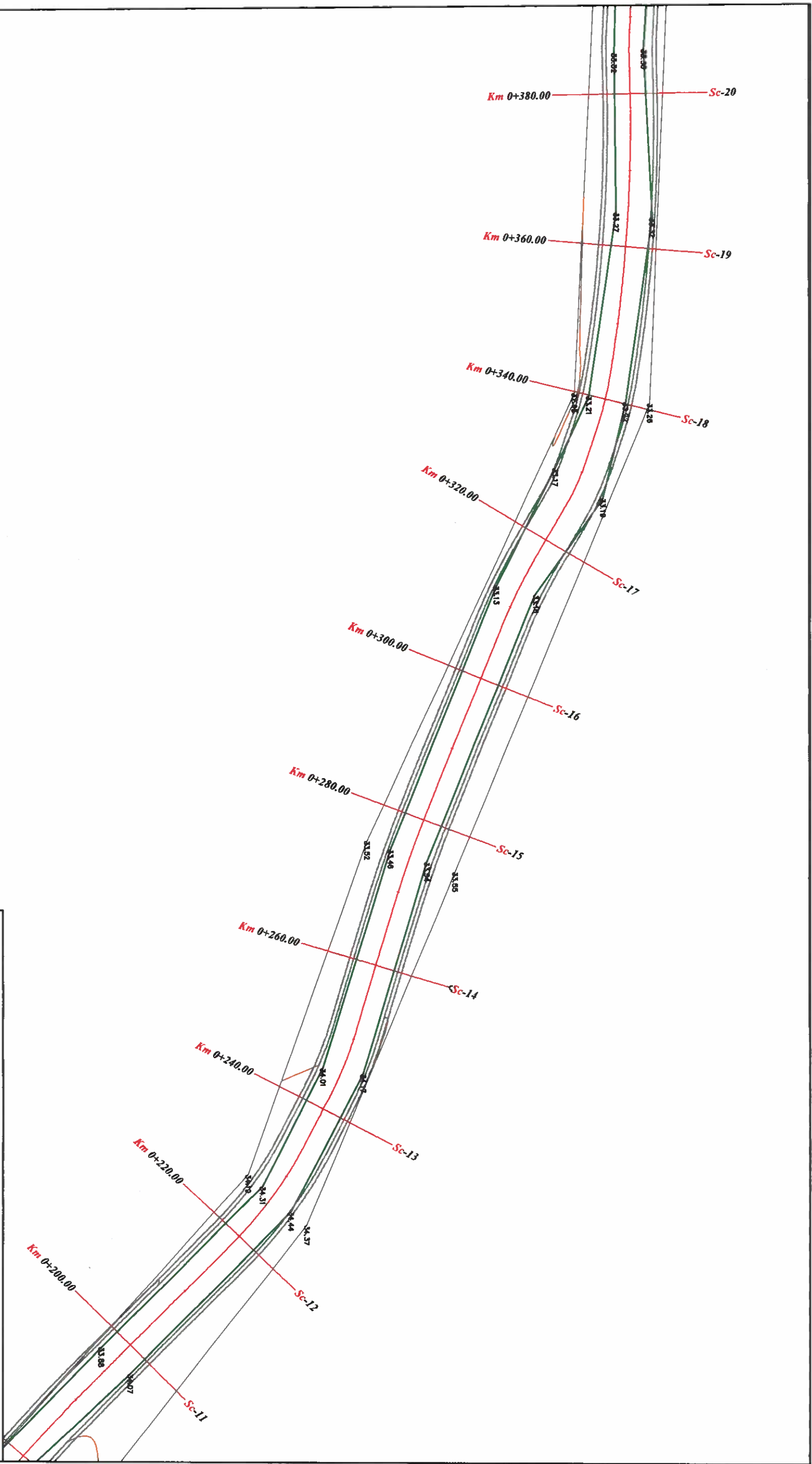

		RIKONSTRUKSIONI RRUGES NGA QENDRA DARZEZE - BREGDET (NE LINDJE)		FLETA K-03	
				TOPOGRAFIA PLANIMETRIA PIK.3"-12	
DR. DEPARTIMETI I INFRASTRUKTURIT DHE TRANSPORTIT	Ing. Haxhi Avdullai	Ing. Haxhi Avdullai			
Proj. Konstruktor	Ark. Erajd TAVANXHIU	Ark. Ilisidor PRIFTI			
Proj. ARKITEKTONIK	G.J. Ilisidor PRIFTI	G.J. Ilisidor PRIFTI	DHAJETOR 2024	BASHKIA FIER	
TOPOGRAF	Bashkia FIER(QARKU FIER)	Bashkia FIER(QARKU FIER)	DHAJETOR 2024	BASHKIA FIER	
POROSITI	Bashkia FIER(QARKU FIER)	Bashkia FIER(QARKU FIER)	DHAJETOR 2024	BASHKIA FIER	

TOPOGRAFIJA E RIKONSTRUKSIONIT TE SEGMENTIT TE RRUGES
 NGA QENDRA DARZEZE DERI NE BREGDET (ANA LINDORE) SH 1:500



		RIKONSTRUKSIONI RRUGES NGA QENDRA DARZEZE - BREGDETE (NE LINDJE)		FLETA K-04	
				TOPOGRAFIJA PLANIMETRIA PK.12-20	
DIRECTIONI I INFRASTRUKTURES	Ing. Haxhi Avdullai	Ing. Haxhi Avdullai			
PROJ. KONSTRUKTOR	Ing. Haxhi Avdullai	Ark. Erajd TAVANXHIU			
PROJ. ARKITEKTONIK	Ark. Erajd TAVANXHIU	Ark. Erajd TAVANXHIU	BASHKIA FIER(QARKU FIER)		
TOPOGRAF	G.J. Ilisidor PRIFTI	G.J. Ilisidor PRIFTI			
POROSITI	Bashkia FIER(QARKU FIER)		DHAJETOR 2024 BASHKIA FIER		

TOPOGRAFIA E RIKONSTRUKSIONIT TE SEGMENTIT TE RRUGES
NGA QENDRA DARZEZE DERI NE BREGDET (ANA LINDORE) SH 1:500

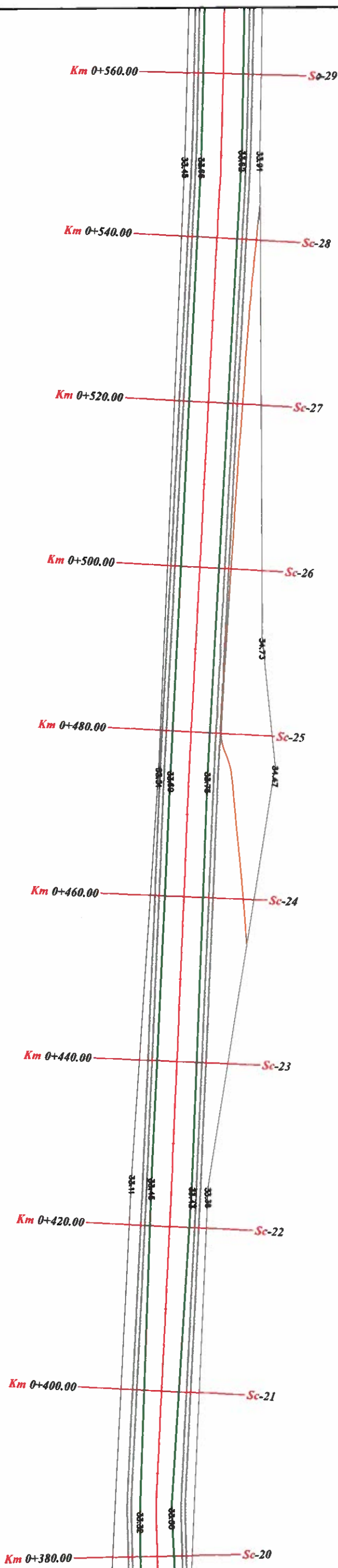

		RIKONSTRUKSIONI RRUGES NGA QENDRA DARZEZE - BREGDETE (NE LINDJE)	
DIREKTORIBETI I PROJEKTIMIT DIPLOMATIKET		Ing.	Haxhi Avdullai
Proi. Konstruktor		Ing.	Haxhi Avdullai
Proi. ARKITEKTONIK		Ark.	Erald TAVANXHIU
TOPOGRAF		GJ	Isidor PRIFTI
POROSITI		Bashkia FIER(QARKU FIER)	
		FLUTA K-05	
		TOPOGRAFIA PLANIMETRIA PK.20-29	
		DHJETOR 2024	
		BASHKIA FIER	

TOPOGRAFIA E RIKONSTRUKSIONIT TE SEGMENTIT TE RRUGES
 NGA QENDRA DARZEZE DERI NE BREGDET (ANA LINDORE) SH 1:500

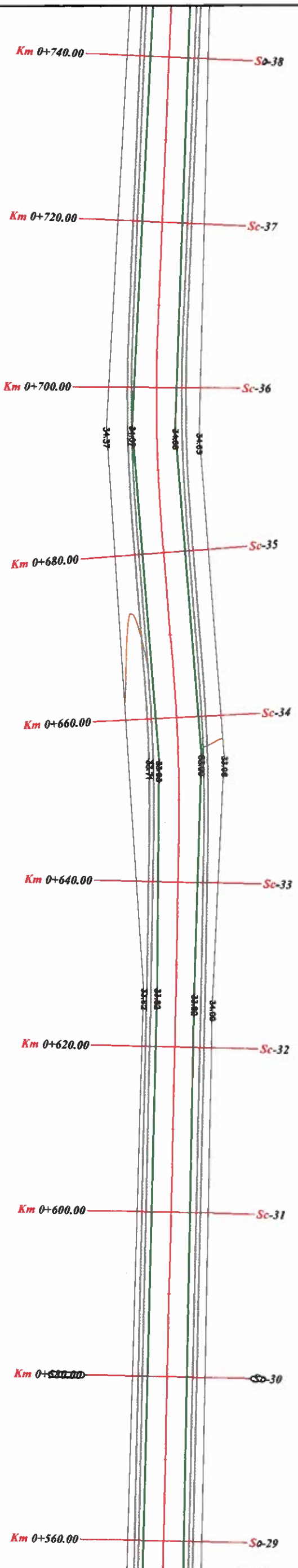



 <p>RIKONSTRUKSIONI RRUGES NGA QENDRA DARZEZE - BREGDETE (NE LINDJE)</p>		<p>FLETA K-06</p>	
		<p>TOPOGRAFIA PLANIMETRIA P.K.29-38</p>	
<p>DIREKTORIBETI I PROJEKTIMIT DHE INZHINIERIT</p>	<p>Ing. Haxhi Avdullai</p>	<p>Ing. Haxhi Avdullai</p>	<p>Ing. Haxhi Avdullai</p>
<p>PROJ. KONSTRUKTOR</p>	<p>Ark. Erald TAVANXHIU</p>	<p>Ark. Erald TAVANXHIU</p>	<p>Ark. Erald TAVANXHIU</p>
<p>PROJ. ARKITEKTONIK</p>	<p>GJ. Isidor PRIFTI</p>	<p>GJ. Isidor PRIFTI</p>	<p>GJ. Isidor PRIFTI</p>
<p>TOPOGRAF</p>	<p>Bashkia FIER(QARKU FIER)</p>		
<p>POKOSITI</p>	<p>BASHKIA FIER</p>		



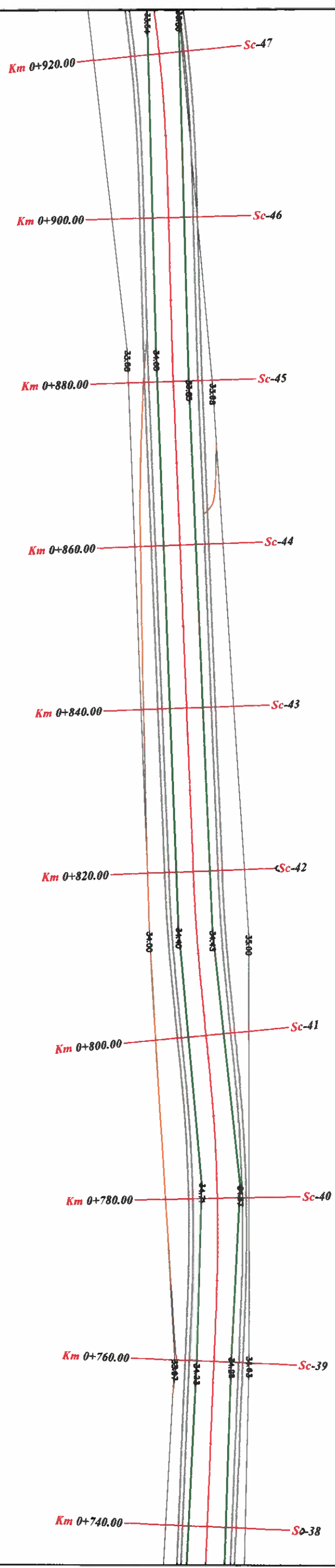

TOPOGRAFIA E RIKONSTRUKSIONIT TE SEGMENTIT TE RRUGES
 NGA QENDRA DARZEZE DERI NE BREGDET(ANA LINDORE) SH 1:500

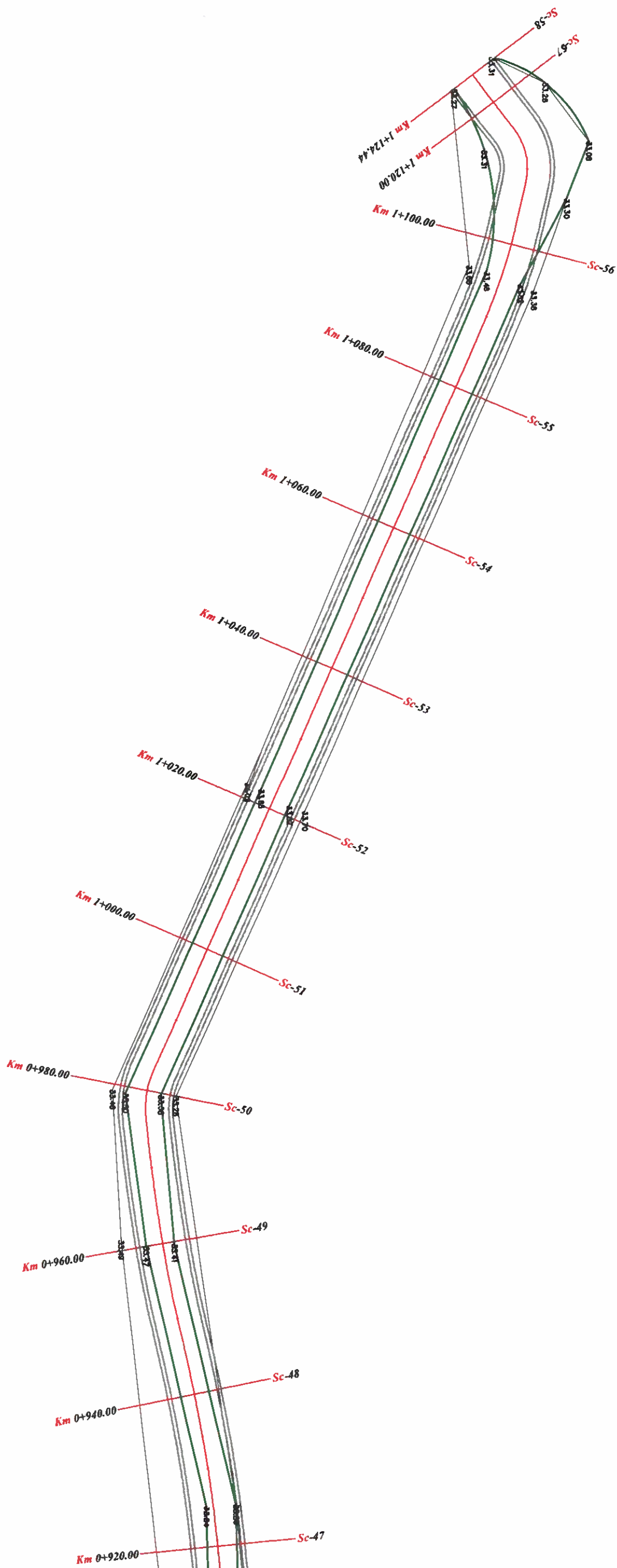

 <p>RIKONSTRUKSIONI RRUGES NGA QENDRA DARZEZE - BREGDET (NE LINDJE) (NE LINDJE)</p>		 <p>FLETA K-07</p>	
		<p>TOPOGRAFIA PLANIMETRIA P.K.38-47</p>	
DREJTORESI SH.P. PROJEKTIME INFRASTRUKTURES	Ing. Haxhi Avdullai	Ark. Erajd TAVANXHIU	GJ. Ihsidor PRIFTI
Proi Konstruktor	Ark. Erajd TAVANXHIU	GJ. Ihsidor PRIFTI	Proi Arkitetorik
POROSITI	Bashkia FIER(QARKU FIER)	DH.ETOR 2024	BASHKIA FIER

TOPOGRAFIA E RIKONSTRUKSIONIT TE SEGMENTIT TE RRUGES
 NGA QENDRA DARZEZE DERI NE BREGDET (ANA LINDORE) SH 1:500



		RIKONSTRUKSIONI RRUGES NGA QENDRA DARZEZE - BREGDETE (NE LINDJE)		FLETA K-07/1
		DIBRËZITËRISIA E INZHINIERËSIAE		
Proj. Konstruktor		Ing. Haxhi Avdullai		TOPOGRAFIA PLANIMETRIA P.K. 38-47
PROJ. ARKITEKTONIK		Ark. Erajd TAVANXHIU		DHJETOR 2024 BASHKIA FIER
TOPOGRAF		GJ. Ihsidor PRIFTI		
POROSITI		Bashkia FIER(QARKU FIER)		BASHKIA FIER



PLANIMETRIA E RIKONSTRUKSIONIT TE SEGMENTIT TE RRUGES
NGA QENDRA DARZEZE DERI NE BREGDET (ANA LINDORE) SH 1:500

Rruga ne Perendim

Pik Fikse Qender dazeze
X=447449.912
Y=4509170.311

Rruga ne Lindje

Pik Fikse Hidrovori 1
X=447492.584
Y=4509112036

Sc-8' Km 0+140.00

2.70

Sc-7'

HIDROVORI 01

Sc-7' Km 0+120.00

Shtesa Asfaltike

Sc-6' Km 0+100.00

4.00

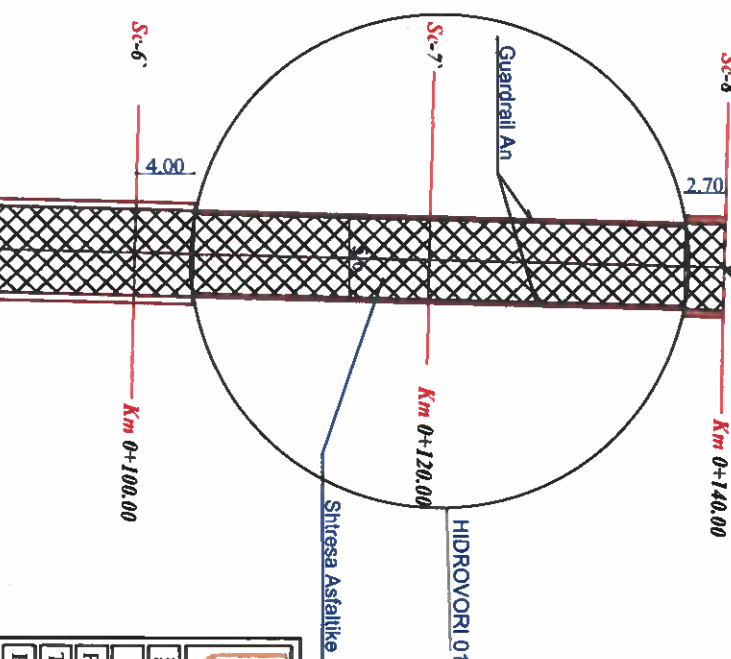



		RIKONSTRUKSIONI RRUGES NGA QENDRA DARZEZE - BREGDET (NE LINDJE)		FLETA K-08
DIKONSTRUKSIONI DHE RIKONSTRUKSIONI DHE REKONSTRUKSIONI	Ing.	Haxhi Avdullai		
PROJ. KONSTRUKTOR	Ing.	Haxhi Avdullai		PLANIMETRIA PIK.08'-08'
PROJ. ARKITEKTONIK	Ark.	Erald TAVANXHIU		DHJETOR 2024
TOPOGRAF	Gj.	Isidor PRIFTI		BASHKIA FIER
POROSITI		Bashkia FIER(QARKU FIER)		



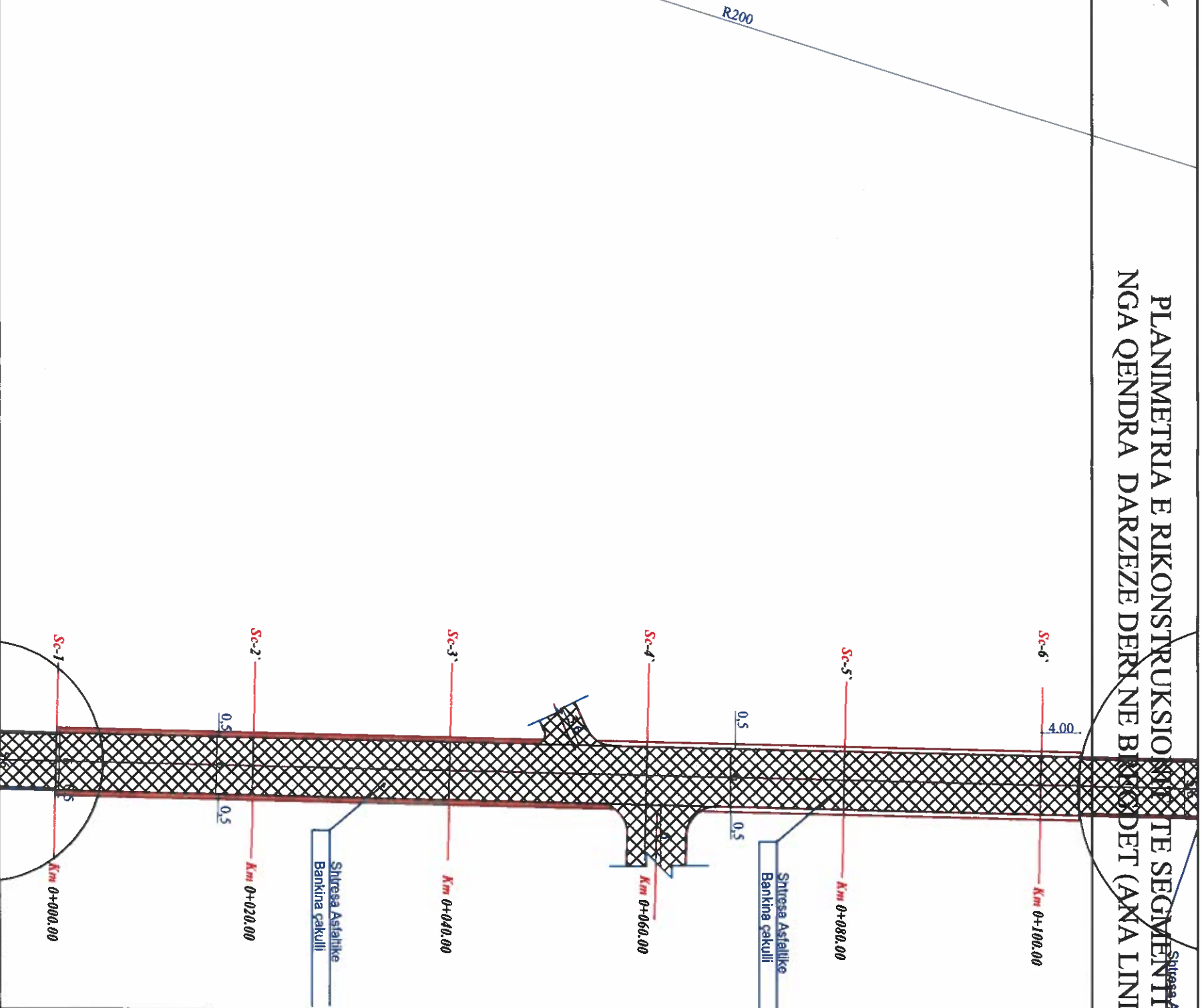

PLANIMETRIA E RIKONSTRUKSIONI NË BREGDET E SEGMENTIT TË RRUGES
 NGA QENDRA DARZEZE DERI NË BREGDET (ANA LINDORE) SH 1:500



 <p>RIKONSTRUKSIONI RRUGES NGA QENDRA DARZEZE - BREGDETE (NE LINDJE)</p>		<p>FLETA K-09</p>		
		<p>PLANIMETRIA P.K.08'-01</p>		
<p>DIREKTORIN E PROJEKTIMIT DIBASTANTIT/ES</p>	<p>Ing.</p>	<p>Haxhi Avdullai</p>		<p>DHJETOR 2024</p>
<p>PROJ. KONSTRUKTOR</p>	<p>Ing.</p>	<p>Haxhi Avdullai</p>		
<p>PROJ. ARKITEKTONIK</p>	<p>Ark.</p>	<p>Erald TAVANXHIU</p>	<p>BASHKIA FIER(QARKU FIER) BASHKIA FIER</p>	<p>BASHKIA FIER</p>
<p>TOPOGRAFI</p>	<p>Gj.</p>	<p>Isidor PRIFTI</p>		
<p>POROSITI</p>				

PLANIMETRIA E RIKONSTRUKSIONIT TE SEGMENTIT TE RRUGES NGA QENDRA DARZEZE DERI NE BREGDET (ANA LINDORE) SH 1:500

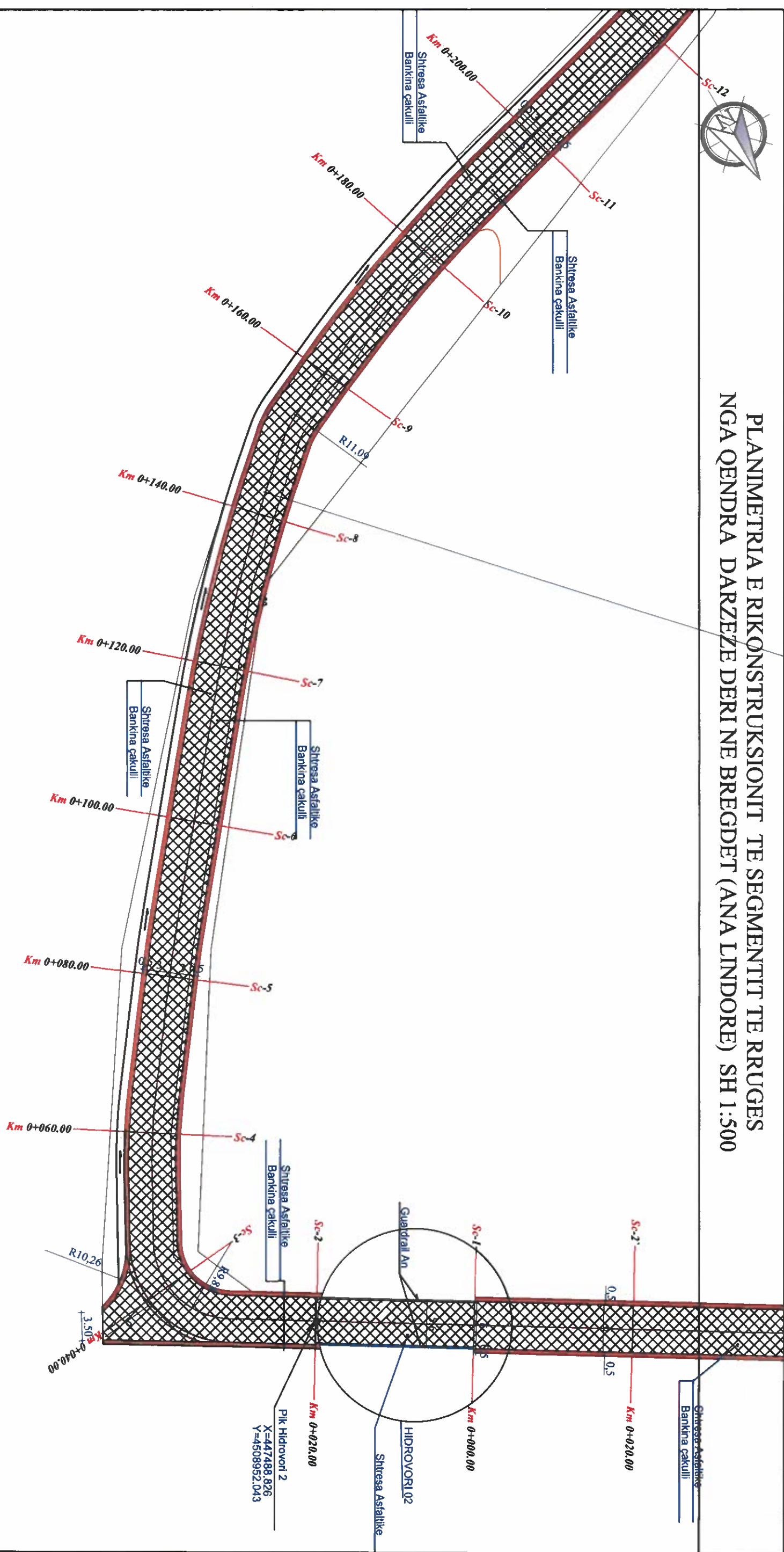

	REPUBLIKA E SHQIPËRIE	MINISTRI E INFRASTRUKTURËS DHE TRANSPORTIT	PROJEKTI
Ing. Haxhi Avdullai	Ing. Haxhi Avdullai	Ark. Erajd TAVANXHIU	Gj. Ilisidor PRIFTI
Proj. Konstruktor	Proj. Arkitëktomik	Topograf	Porositi
Bashkia FIER(QARKU FIER) SHK. 1			BASHKIA FIER

**FLETA
K-10**

PLANIMETRIA
PIK.01-11

DHJETOR 2024

BASHKIA FIER

R37,5



PLANIMETRIA E RIKONSTRUKSIONIT TE SEGMENTIT TE RRUGES NGA QENDRA DARZEZE DERI NE BREGDET (ANA LINDORE) SH 1:500

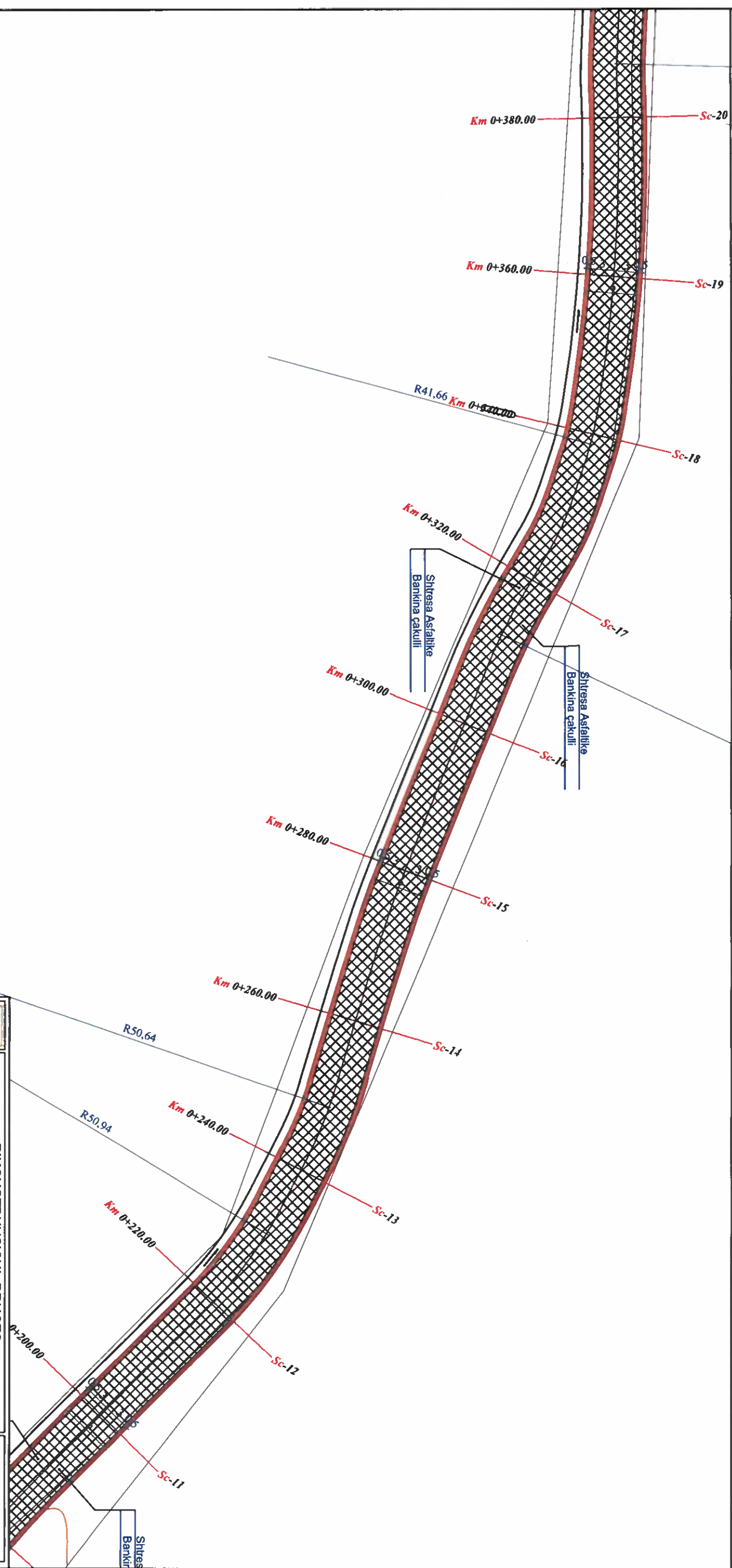

**RIKONSTRUKSIONI RRUGES
NGA QENDRA DARZEZE - BREGDETE
(NE LINDJE)**

**FLETA
K-11**

		DIKONSTRUKSIONI RRUGES NGA QENDRA DARZEZE - BREGDETE (NE LINDJE)		FLETA K-11	
DIKONSTRUKSIONI RRUGES NGA QENDRA DARZEZE - BREGDETE (NE LINDJE)	Ing.	Haxhi Avdullai	Ing.	Haxhi Avdullai	PLANIMETRIA PIK.11-20
PROJ. KONSTRUKTOR	Ark.	Erald JAVANXHIU	Ark.	Erald JAVANXHIU	DHJETOR 2024
PROJ. ARKITEKTONIK	Gj.	Ilisidor PRIFTI	Gj.	Ilisidor PRIFTI	BASHKIA FIER
TOPOGRAFI					
PROJ. POROSIT		Bashkia FIER(QARKU I FIER)			BASHKIA FIER



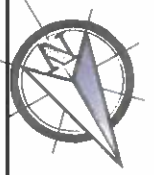

PLANIMETRIA E RIKONSTRUKSIONIT TE SEGMENTIT TE RRUGES
NGA QENDRA DARZEZE DERI NE BREGDET (ANA LINDORE) SH 1:500

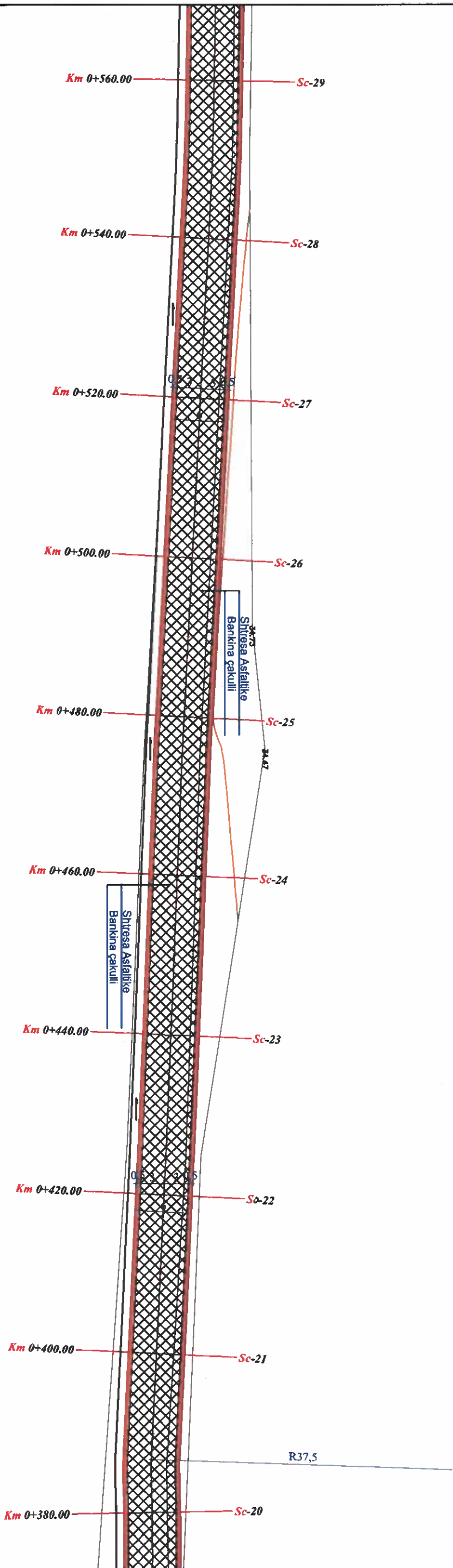

		RIKONSTRUKSIONI RRUGES NGA QENDRA DARZEZE - BREGDETE (NE LINDJE)		FLETA K-12
DIKTORE I PROJEKTEVE REKONSTRUKSIONIT RR	Ing.	Haxhi Avdullai		
PROJ. KONSTRUKTOR	Ing.	Haxhi Avdullai		PLANIMETRIA PIK. 20-28
PROJ. ARKITEKTONIK	Ark.	Eraild TAVANXHIU		
TOPOGRAFI	Gj.	Ilisidor PRIFTI		DHJETOR 2024
POROSITI		Bashkia FIER(QARKU FIER)		BASHKIA FIER



PLANIMETRIA E RIKONSTRUKSIONIT TE SEGMENTIT TE RRUGES
NGA QENDRA DARZEZE DERI NE BREGDET (ANA LINDORE) SH 1:500

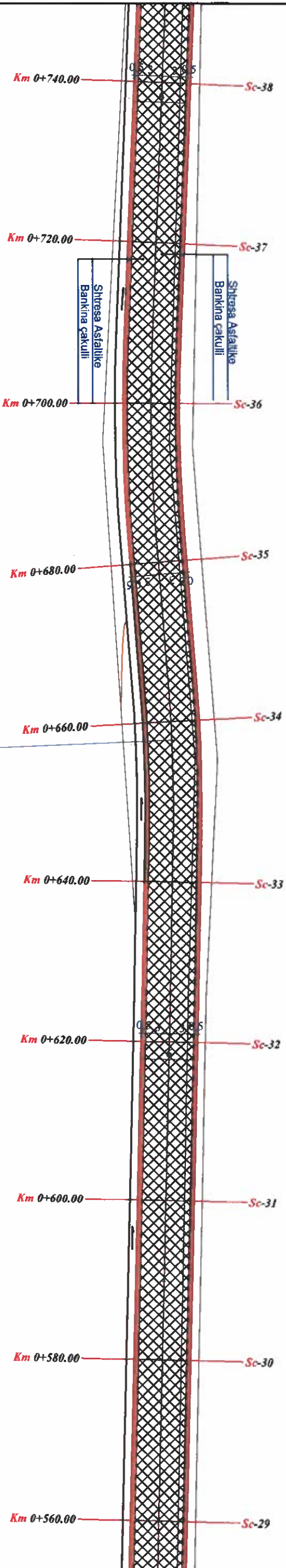

		RIKONSTRUKSIONI RRUGES NGA QENDRA DARZEZE - BREGDETE (NE LINDJE)		FLETA K-13
ORGANIZIMI I PROJEKTEVE TE INZHINIERIA	Ing.	Haxhi Avdullai		
PROJ. KONSTRUKTOR	Ing.	Haxhi Avdullai		PLANIMETRIA Pik. 29-38
PROJ. ARKITEKTONIK	Ark.	Erald TAVANXHIU		DHJETOR 2024
TOPOGRAFI	Gj.	Ilisidor PRIFTI		BASHKIA FIER
POROSITI		Bashkia FIER(QARKU FIER)		



PLANIMETRIA E RIKONSTRUKSIONIT TE SEGMENTIT TE RRUGES
NGA QENDRA DARZEZE DERI NE BREGDET (ANA LINDORE) SH 1:500

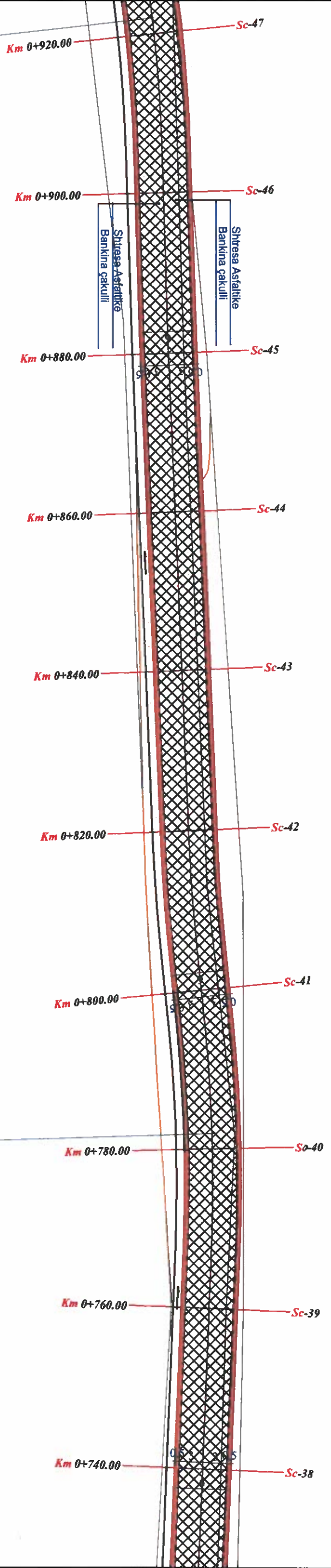

		RIKONSTRUKSIONI RRUGES NGA QENDRA DARZEZE - BREGDETE (NE LINDJE)		FLETA K-14
DIREKTORIN E PROJEKTIMIT DIPLOMUAR	Ing.	Haxhi Avdullai		
PROJ. KONSTRUKTOR	Ing.	Haxhi Avdullai		PLANIMETRIA PK.38-47
PROJ. ARKITEKTONIK	Ark.	Erald TAVANXHIU		DHJETOR 2024
TOPOGRAF	G.L.	Isidor PRIFTI		
DOKUMENTI		Bashkia FIER(QARKU FIER)		BASHKIA FIER





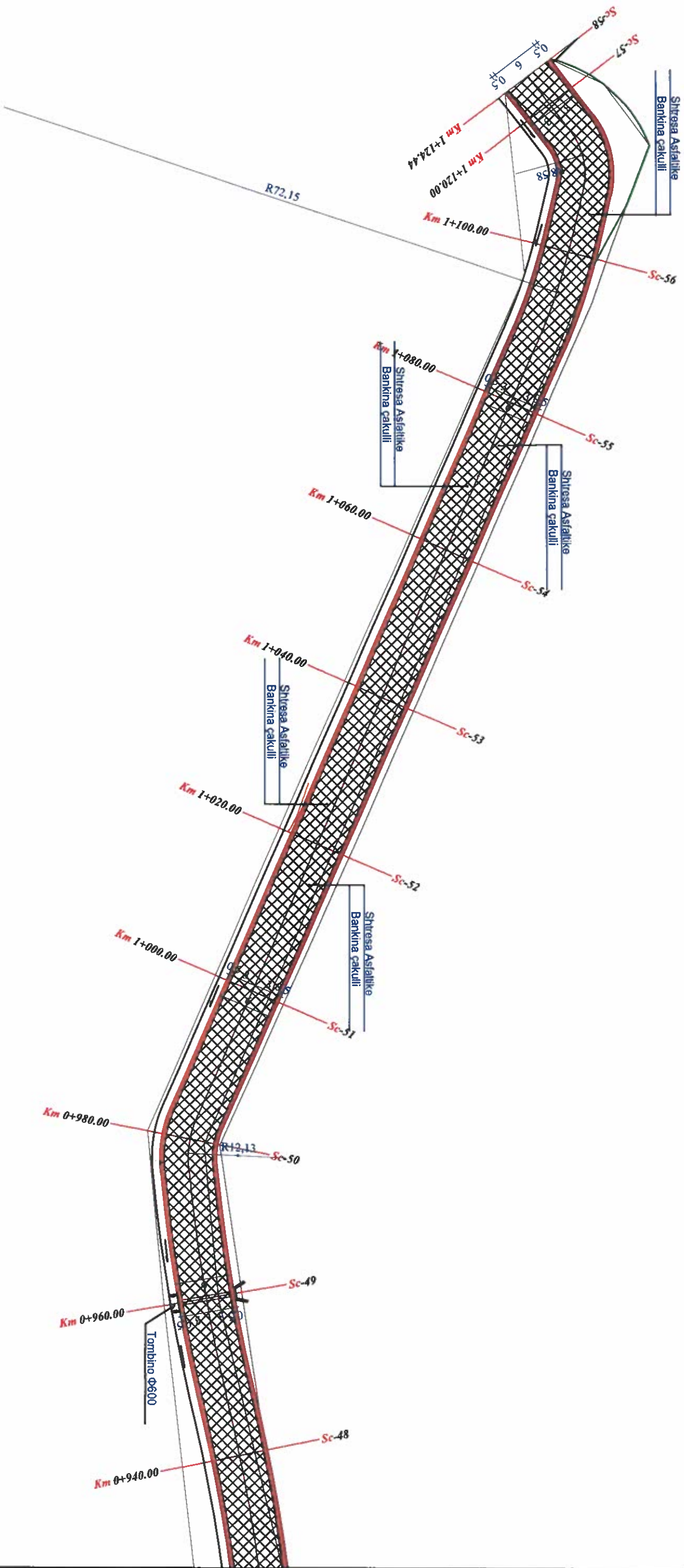

PLANIMETRIA E RIKONSTRUKSIONIT TE SEGMENTIT TE RRUGES NGA QENDRA DARZEZE DERI NE BREGDET (ANA LINDORE) SH 1:500

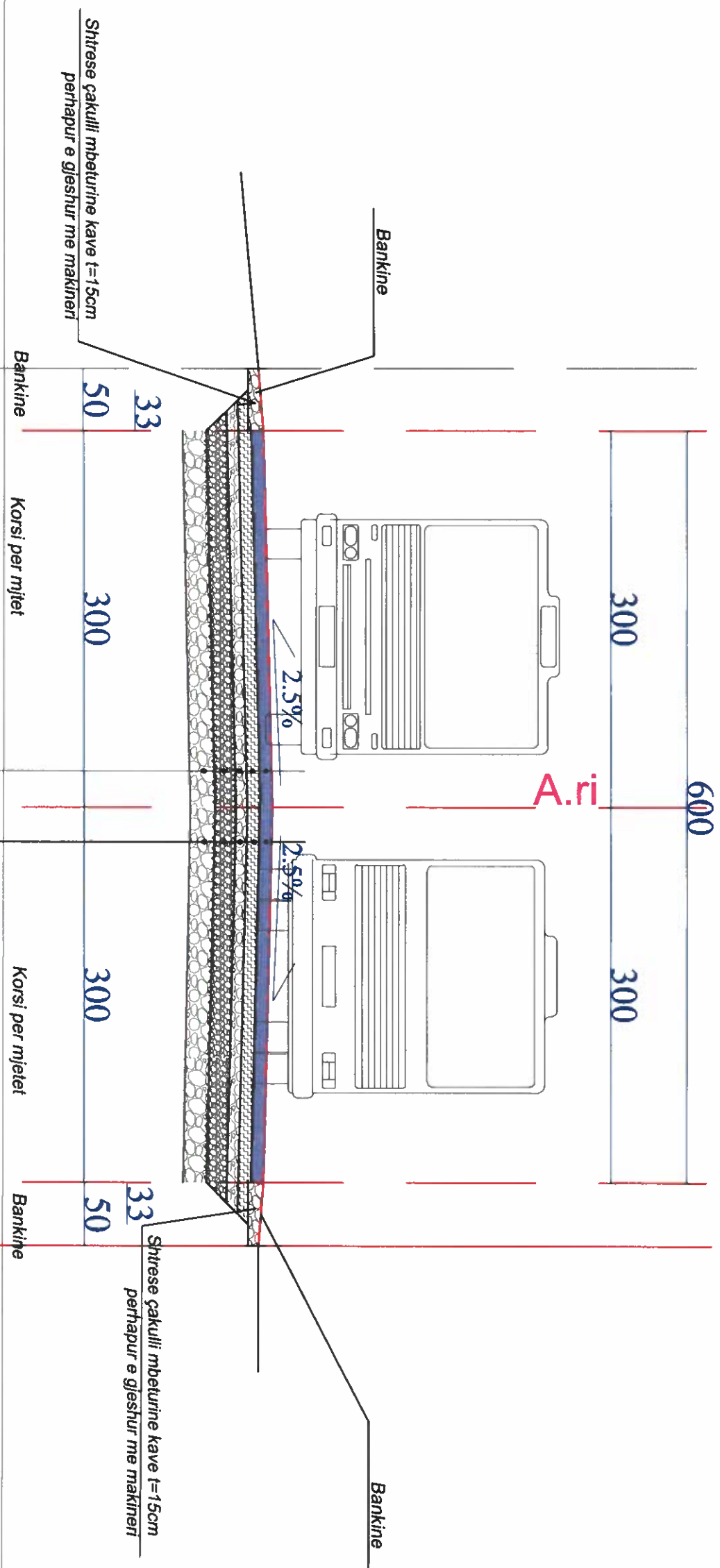

		RIKONSTRUKSIONI RRUGES NGA QENDRA DARZEZE - BREGDETE (NE LINDJE)		FLETA K-15
REDAKTOR/INZHINJER I PROJEKTEVE TE RREZISTIVIT/IT	Ing.	Haxhi Avdullai		
PROJ. KONSTRUKTOR	Ing.	Haxhi Avdullai		PLANIMETRIA PIK.47-58
PROJ. ARKITEKTONIK	Ark.	Erald TAVANXHIU		
TOPOGRAFI	CJ.	Ilisidor PRIFTI		DHJETOR 2024
POROSITI		Bashkia FIER(QARKU FIER) SHKUR		BASHKIA FIER

PROFILI TIP I RIKONSTRUKSIONIT DHE ZGJERIMIT TE SEGMENTIT TE
 RRUGES NGA URA DARZEZE DERI KE URA E DERA E DERIKUT PIK.01-03
 SH 1:500



 <p>MINISTRI I INFRASTRUKTURËS DHE TRANSPORTIT REPUBLICAN</p>		<p>RIKONSTRUKSIONI RRUGES NGA QENDRA DARZEZE – BREGDETË (NE LINDJE)</p>		<p>FLETA K-16</p>	
<p>PROJEKTUESI Proj. Konstruktor</p>	<p>Ing. Haxhi Avdullai</p>	<p>PROJEKTUESI Proj. Arkitekturor</p>	<p>Ark. Erald TAVANXHIU</p>	<p>PROFILI TIP I RIKONSTRUKSIONIT TE RRUGES PIK.01-PIK.03</p>	<p>DHJETOR 2024</p>
<p>TOPOGRAF</p>	<p>Gj. Ilisidor PRIFTI</p>	<p>PROJEKTUESI Bashkia FIER(QARKU FIER)</p>	<p>PROJEKTUESI Bashkia FIER</p>	<p>DHJETOR 2024</p>	<p>BASHKIA FIER</p>
<p>POROSITI</p>	<p>PROJEKTUESI Bashkia FIER(QARKU FIER)</p>	<p>PROJEKTUESI Bashkia FIER</p>	<p>PROJEKTUESI Bashkia FIER</p>	<p>DHJETOR 2024</p>	<p>BASHKIA FIER</p>

PROFILI TIP I RIKONSTRUKSIONIT DHE ZGJERIMIT TE SEGMENTIT TE RRUGES NGA URA DARZEZE DERI KE URA E DERA E DERIKUT PIK.03-58
SH 1:500

A.ri

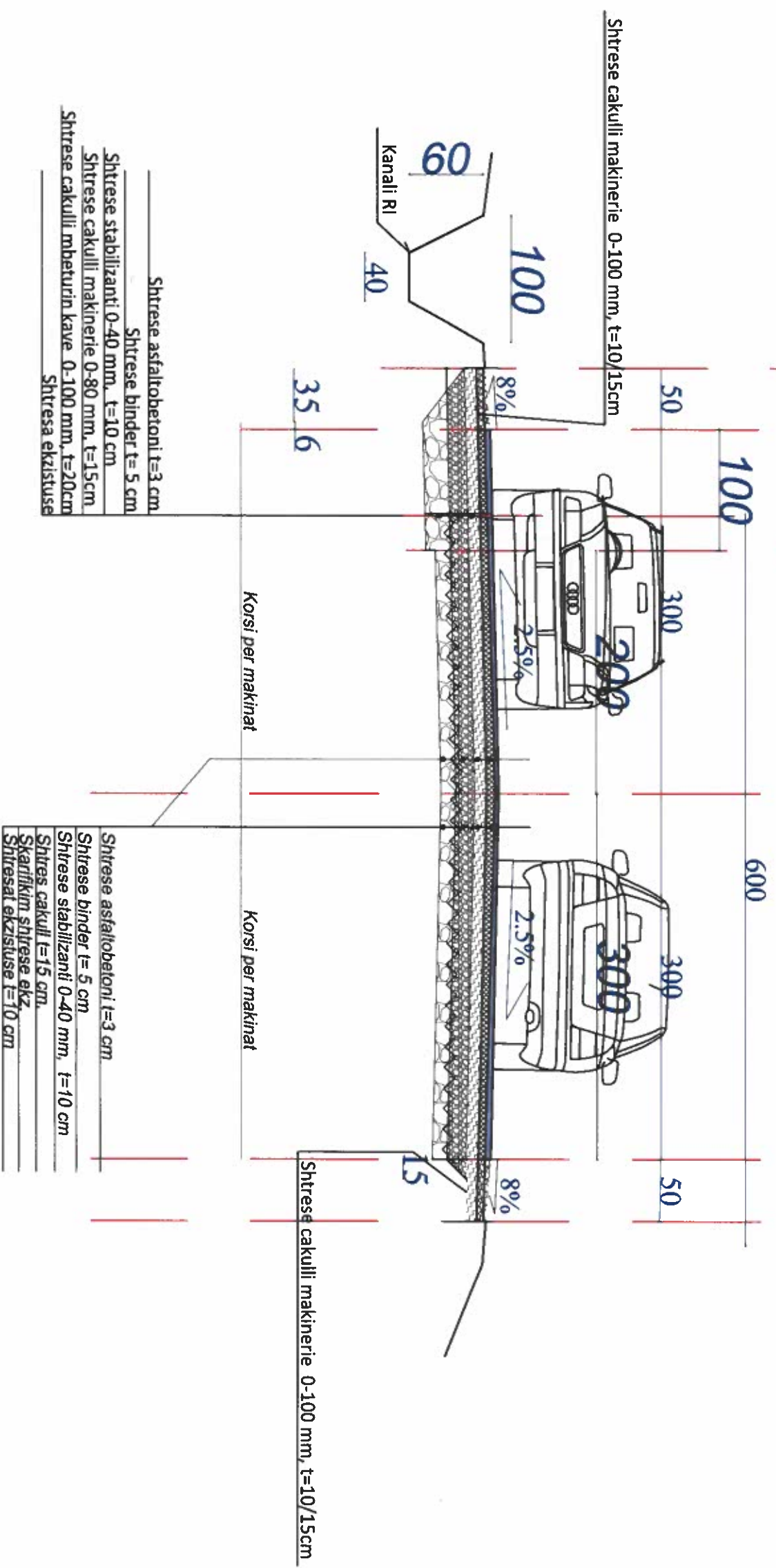

Shtrese cakulli makinerie 0-100 mm, t=10/15cm
Shtrese asfaltobetoni t=3 cm
Shtrese binder t= 5 cm
Shtrese stabilizanti 0-40 mm, t=10 cm
Shtrese cakulli makinerie 0-80 mm, t=15cm
Shtrese cakulli mbeturin kave 0-100 mm, t=20cm
Shtresa ekzistuse

Shtrese asfaltobetoni t=3 cm
Shtrese binder t= 5 cm
Shtrese stabilizanti 0-40 mm, t=10 cm
Shtres cakull t=15 cm.
Skarifikim shtrese ekz.
Shtresat ekzistuse t=10 cm

Shtrese cakulli makinerie 0-100 mm, t=10/15cm

		RIKONSTRUKSIONI RRUGES NGA QENDRA DARZEZE – BREGDETË (NE LINDJE)		FLETA K-17
DIBASTROUESI I PROJEKTTËS TE DIBASTROUESITËS	Ing.	Haxhi Avdullai	PROFILI TIP I RIKONSTRUKSIONIT TE RRUGES PIK03-PIK08	DHJETOR 2024 BASHKIA FIER
PROJ. KONSTRUKTOR	Ing.	Haxhi Avdullai		
PROJ. ARKITEKTONIK	Ark.	Erald TAVANXHIU		
TOPOGRAFI	Gj.	Ilisidor PRIFTI		
POROSITI	BASHKIA FIER(QARKU FIER)			

NDERITIMI I TOMBINOS NE PIK.49

PLANIMETRIA

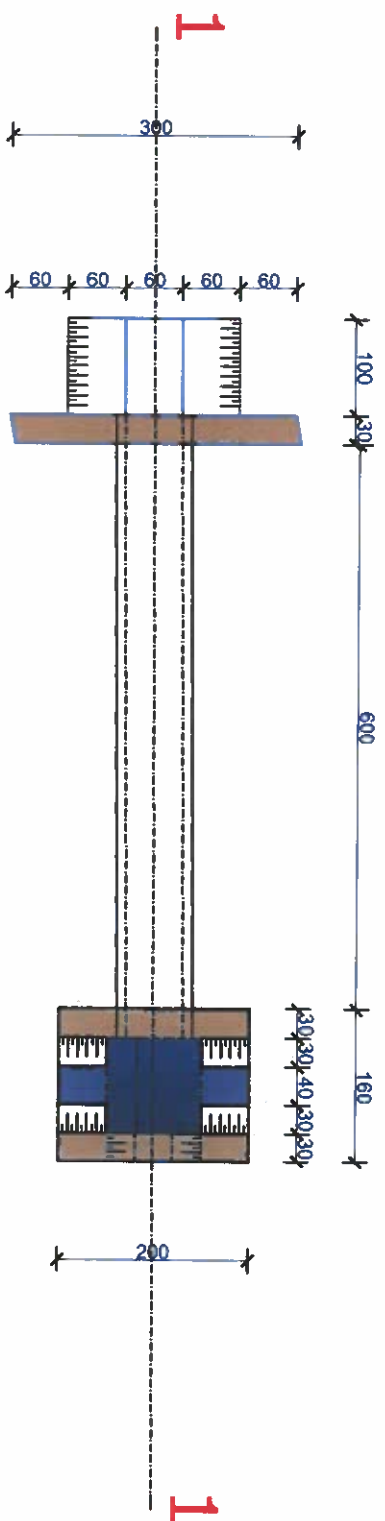

VOLUMET PER 1 TOMBINO

Germime = 16 m³

Beton m-200 per portale = 7.8m³

Tombino Ø 600 = 7 cope tobo

PRERJA 1-1

- Shtresat asfaltike (5+3)
- Shtrese stabilizanti t=10cm
- Shtrese cakulli makinerie t=15cm
- Shtrese cakulli t=20cm
- Shtrese dheu i t=15cm

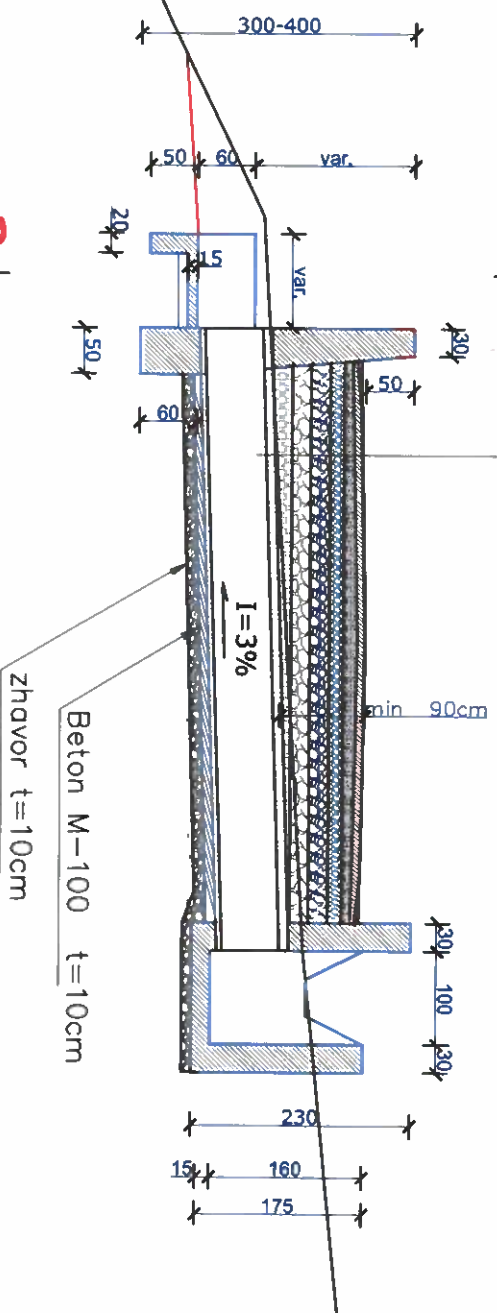

PRERJA 2-2

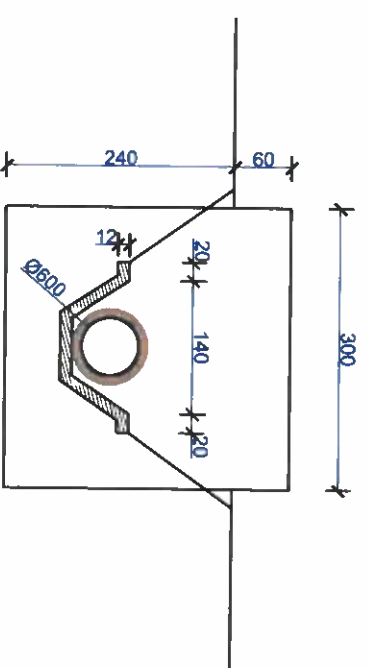

RIKONSTRUKSIONI RRUGES NGA QENDRA DARZEZE - BREGDETE (NE UNDJE)

FLETA
K-18

PROJEKTOR	Ing. Haxhi Avdullai	PROJEKTOR	Ing. Haxhi Avdullai
PROJEKTOR	Ing. Haxhi Avdullai	PROJEKTOR	Ing. Haxhi Avdullai
PROJ. ARKITEKTONIK	Ark. Erald TAVANXHIU	PROJ. ARKITEKTONIK	Ark. Erald TAVANXHIU
TOPOGRAFI	Gj. Ihsidor PRIFTI	TOPOGRAFI	Gj. Ihsidor PRIFTI
POMOSITI	Bashkia FIER(QARKU FIER)	POMOSITI	Bashkia FIER(QARKU FIER)

DIKONSTRUKSIONI I TOMBINOS
PR.49
DHJETOR 2024
BASHKIA FIER

**SINJALISTIKA E RIKONSTRUKSIONIT TE SEGMENTIT TE RRUGES
NGA QENDRA DARZEZE DERI NE BREGDET
(ANA LINORE) SH 1:100**

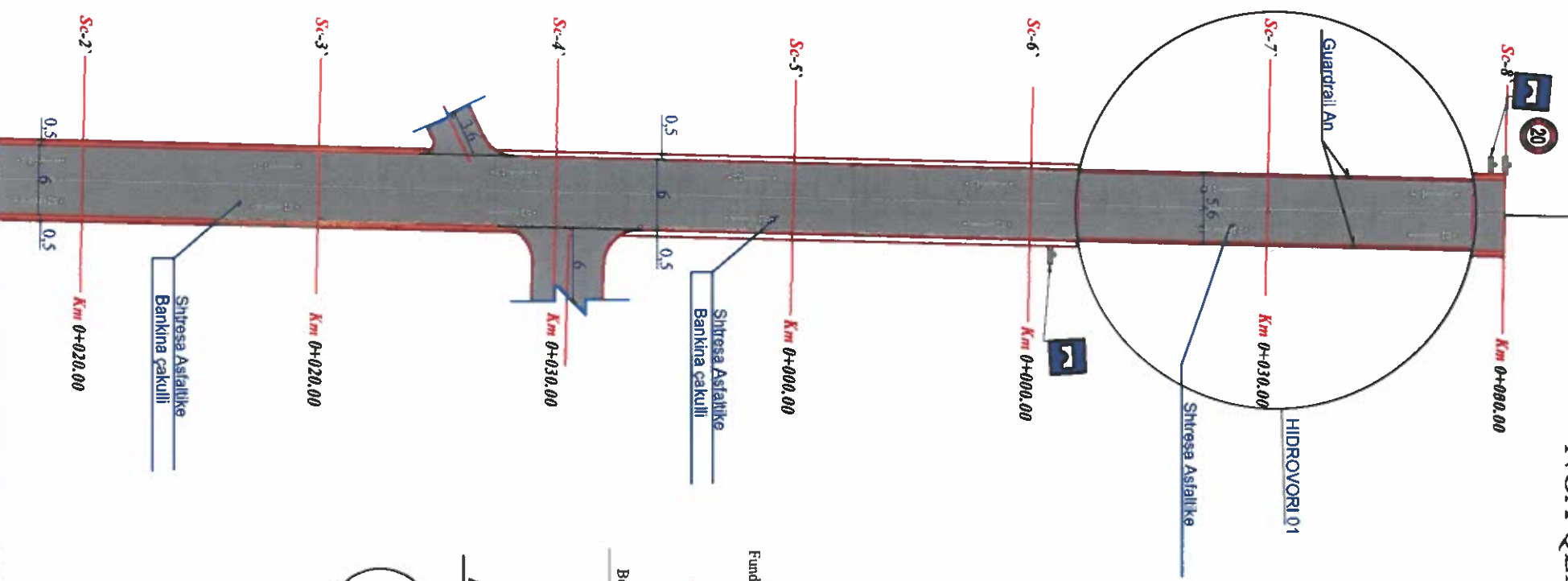

MENYRA E VENDOSIES SE TABELAVE RRUGORE SH.1:10

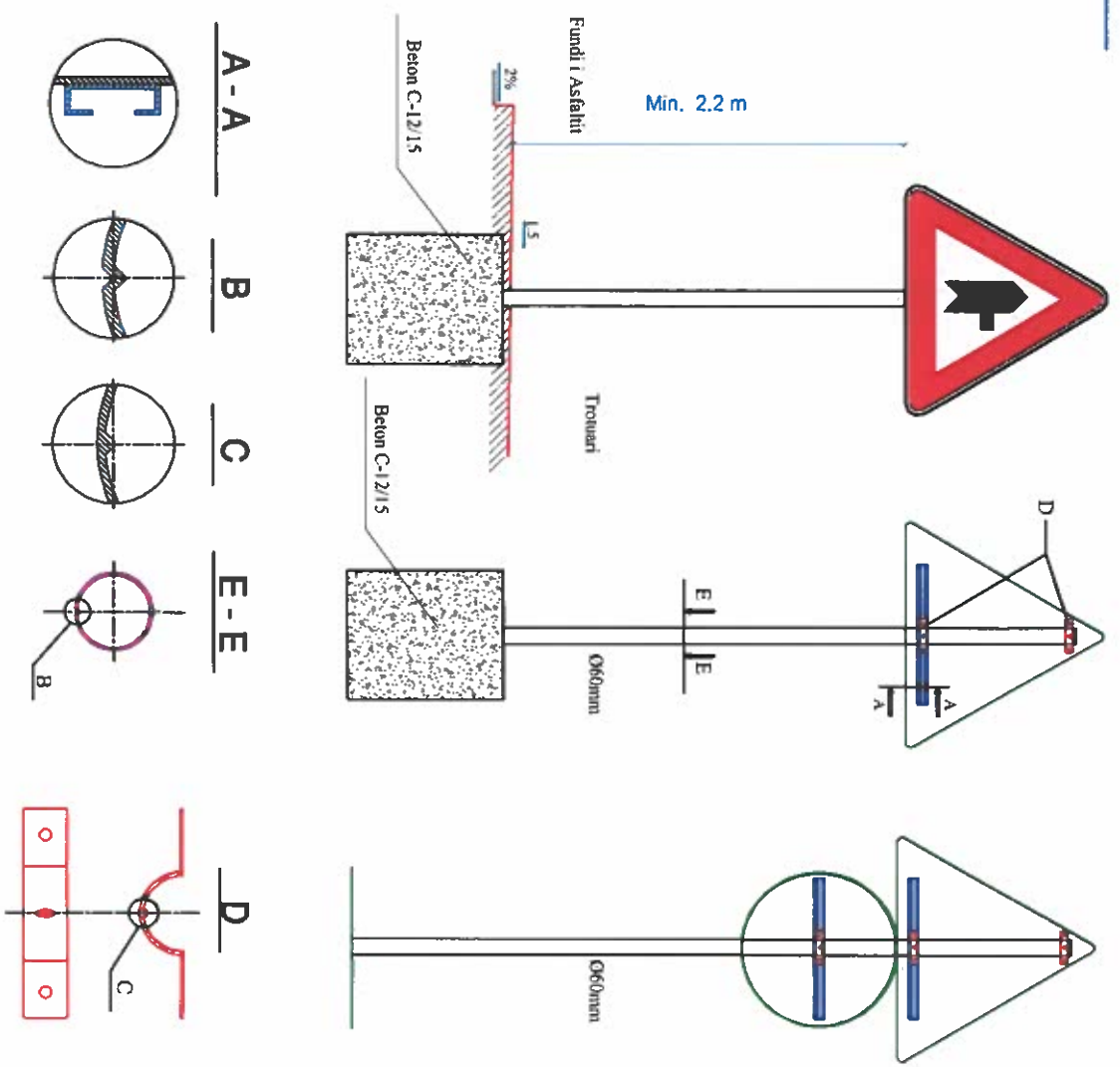

		RIKONSTRUKSIONI RRUGES NGA QENDRA DARZEZE - BREGDET (NE LINDJE)		PLAN K-19
		SHALLISTIKA PK.00-02'		
Ing.	Hasbi Avdullaj	Ing.	Hasbi Avdullaj	
Proj. Konstruktor	Hasbi Avdullaj	Ark.	Ernid TAVANXHIU	
Proj. ARKITEKTONIK	Ernid TAVANXHIU	Ark.	Ernid TAVANXHIU	
Topograf	Ilisder PRUPTI	GAJ.	Ilisder PRUPTI	
POROSITI	Bashkia FIER(QARKU FIER)	GAJ.	Bashkia FIER(QARKU FIER)	DHAKTORI 2024 BASHKIA FIER

SINJALISTIKA E RIKONSTRUKSIONIT TE SEGMENTIT TE RRUGES
 NGA QENDRA DARZEZE DERI NE BREGDET
 (ANA LINOIRE) SH 1:100

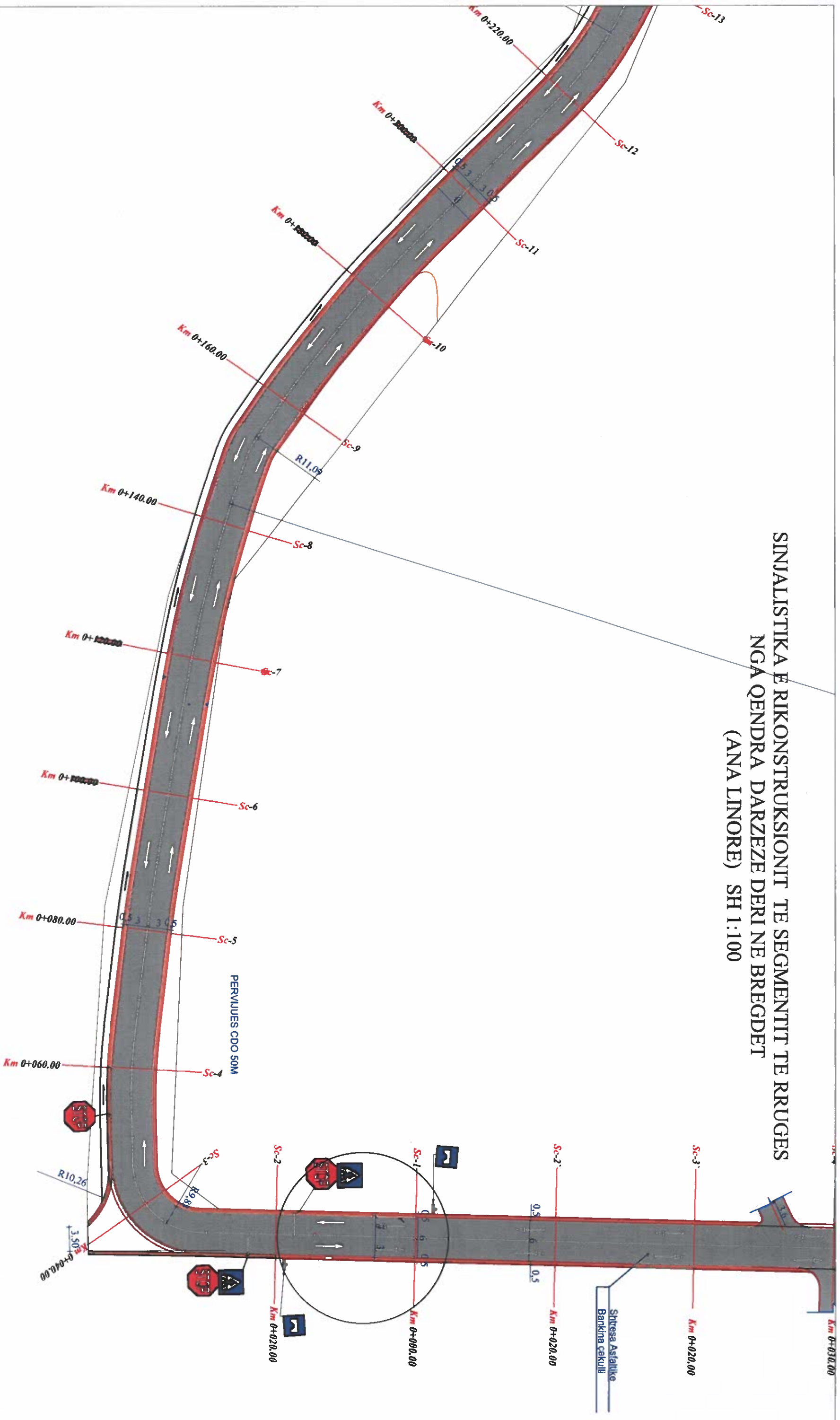

 RIKONSTRUKSIONI RRUGES NGA QENDRA DARZEZE - BREGDET (NE LINOIRE)		RRTJA K-20	
		SHALISTIKA PK.02-12 DHJETOR 2024 BASHKIA FIET	
DISENYER/INZHINIERI I RRUGES Prof. Konstruktior PAOL ARSHITKTOREK	INGJINIERI Ing. Hashi Avdullai Hashi Avdullai	DISENYER/INZHINIERI I RRUGES Prof. Konstruktior PAOL ARSHITKTOREK	INGJINIERI Ing. Hashi Avdullai Hashi Avdullai
TROPICAR Pionieri	GJL Hektor PROFIT	Bashkia FIERQARKU FIET	BASHKIA FIET

PROFILAT TERTHOR I SEGMENTIT TE RRUGES QENDER DARZEZE - BREGDETE (PERENDIM) SH.1:100

SEKSIONI NR. : 01
Dist. Progressive 0+000.000
Dist. Paraardhese: 00.000
Dist. Pasardhese: 20.000

Kouta ref.31.00

Kuota Terrenit									
Progresiva Terrenit	2.18	2.18	0.00	0.00	0.00	0.00	4.60	31.28	
Kuota Projektit									
Progresiva Projektit	Kanal	0.50	3.00	0.00	3.00	0.50	Bankin		

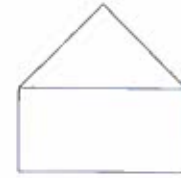

Gjermi i trupit te rruges kazonate	3.08 m ²
Mbulimje me Çelull(Shavor)	0.00 m ²

SEKSIONI NR. : 02
Dist. Progressive 0+020.000
Dist. Paraardhese: 20.000
Dist. Pasardhese: 20.000

Kouta ref.30.00

Kuota Terrenit									
Progresiva Terrenit	2.18	2.18	0.00	0.00	0.00	0.00	4.60	31.28	
Kuota Projektit									
Progresiva Projektit	Kanal	0.50	3.00	0.00	3.00	0.50	Bankin		

Gjermi i trupit te rruges kazonate	2.72m ²
Mbulimje me Çelull(Shavor)	0.00 m ²

SEKSIONI NR. : 03
Dist. Progressive 0+040.000
Dist. Paraardhese: 20.000
Dist. Pasardhese: 20.000

Kouta ref.30.00

Kuota Terrenit									
Progresiva Terrenit	7.57	3.82	0.00	1.55	2.72	8.00	31.48		
Kuota Projektit									
Progresiva Projektit	Kanal	0.50	3.00	0.00	3.00	0.50	Bankin		

Gjermi i trupit te rruges kazonate	1.14m ²
Mbulimje me Çelull(Shavor)	0.002 m ²

	RIKONSTRUKSIONI RRUGES NGA QENDRA DARZEZE - BREGDETE (ANA LINDORE)	FLETA K-21
BEKIMULLI QAZI DREKTOR	Ing. Haxhi Avdullai	PROFILI TERTHOR (PK.01-03)
Proj. Konstruktor	Ing. Haxhi Avdullai	
Proj. Arkitektone	Ark. Erald TAVANXHIU	
Topograf	Gj. Ilisidor PRIFTI	
Porositi	Bashkia FIER(QARKU FIER)	KURT 2025 BASHKIA FIER

**PROFILAT TERTHOR I SEGMENTIT TE RRUGES
QENDER DARZEZE - BREGDETE (PERENDIM) SH.1:100**

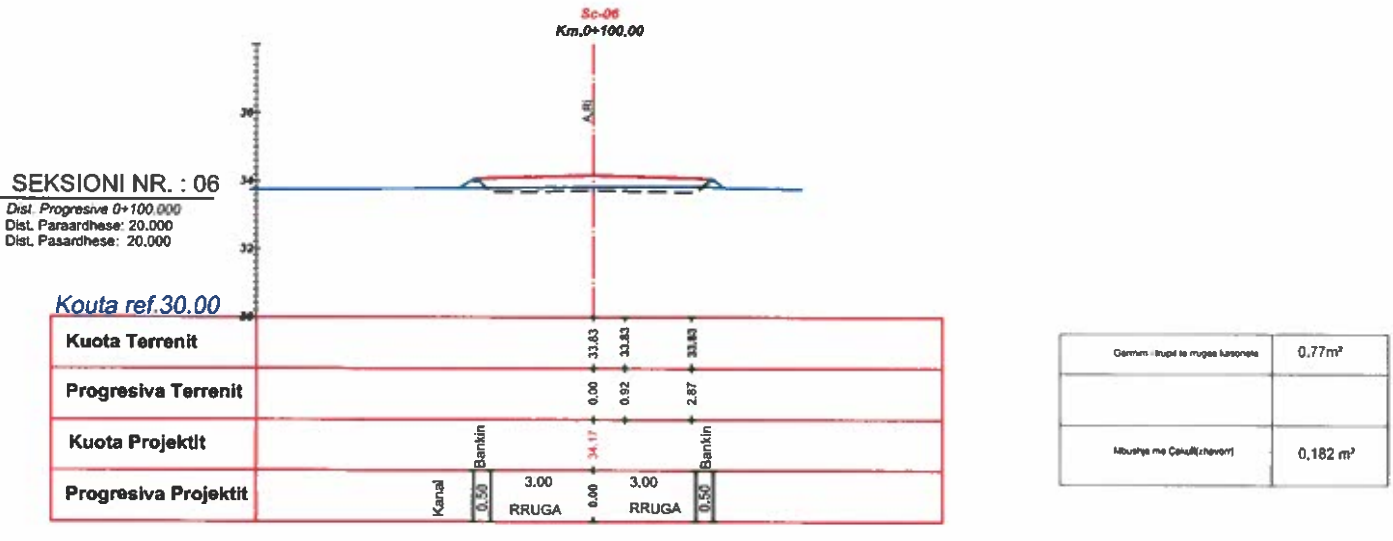
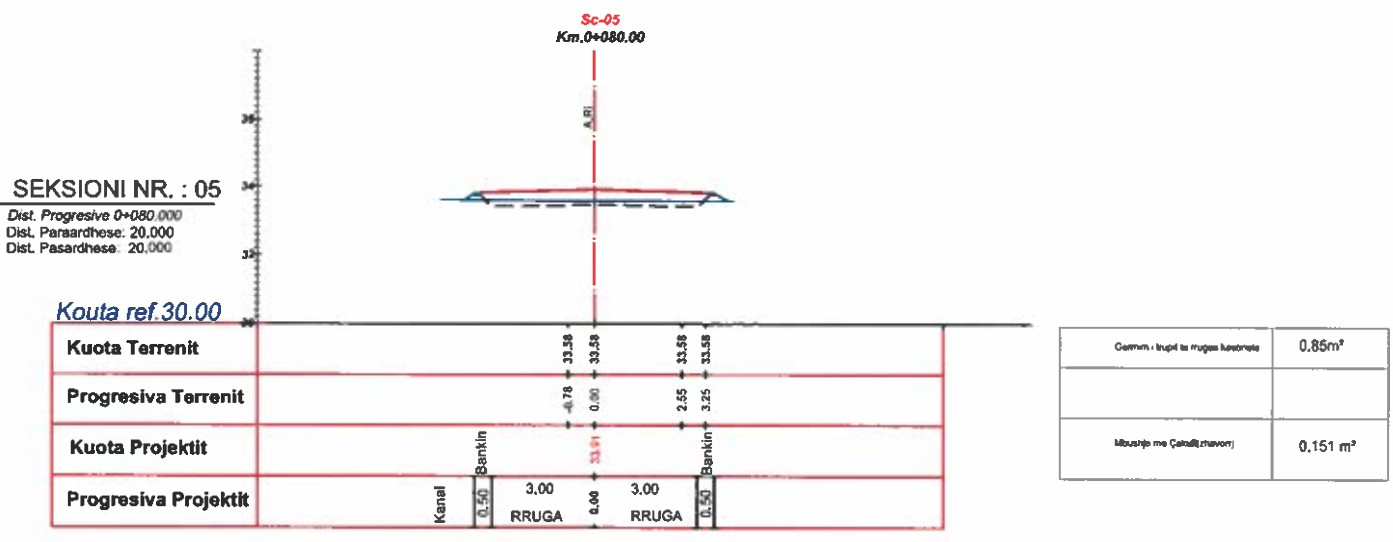
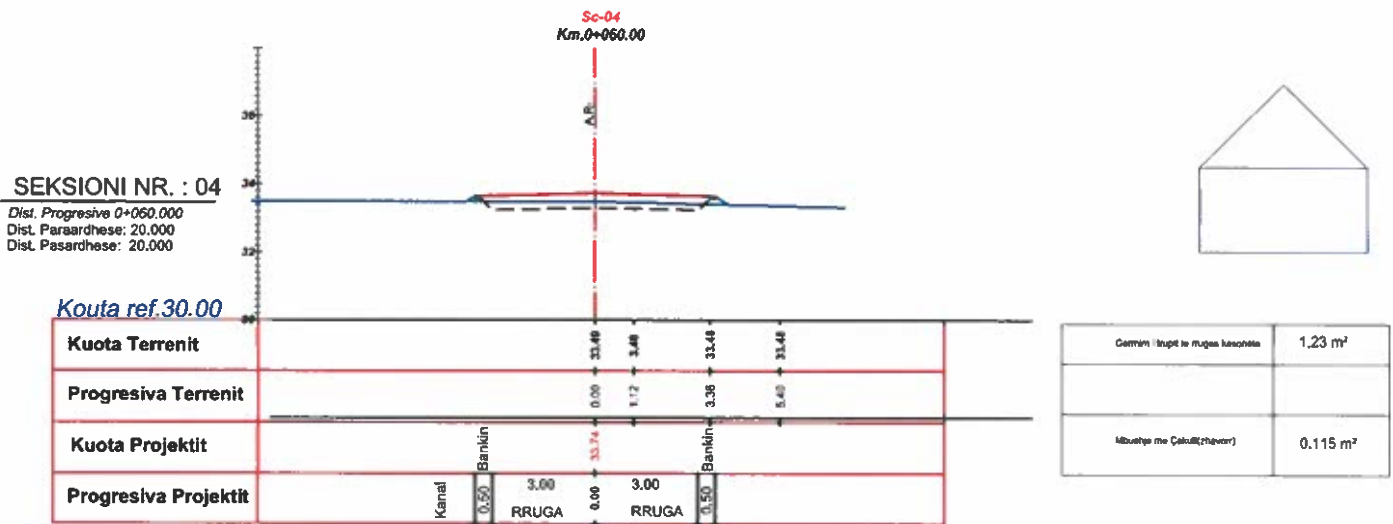

RIKONSTRUKSIONI RRUGES NGA QENDRA DARZEZE - BREGDETE (ANA LINDORE)		FLIETA K-22
Proj. Konstruktor	Ing. Haxhi Avdullah	
Proj. Arkitektikonik	Ark. Erald TAVANXHITU	
Topograf	Gj. Ilisidor PRIETI	
Porosit	Bashkia FIER(QARKU FIER)	
		PROFILI TERTHORE (PK.04-06) SHKURT 2025 BASHKIA FIER

**PROFILAT TERTHOR I SEGMENTIT TE RRUGES
QENDER DARZEZE - BREGDETE (PERENDIM) SH.1:100**

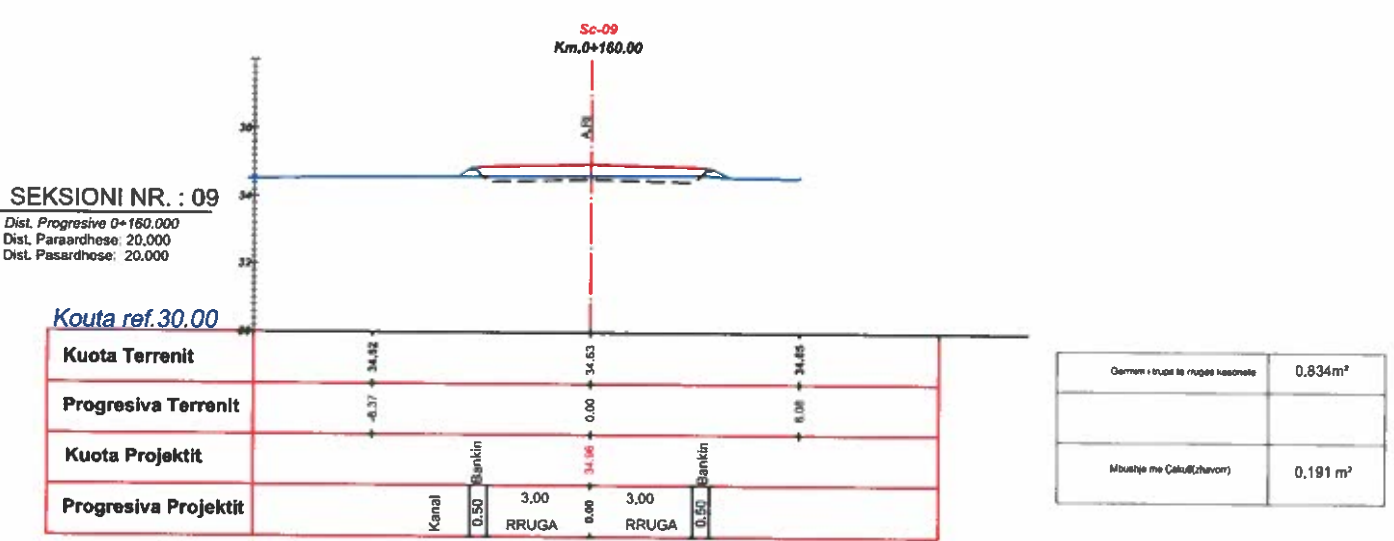
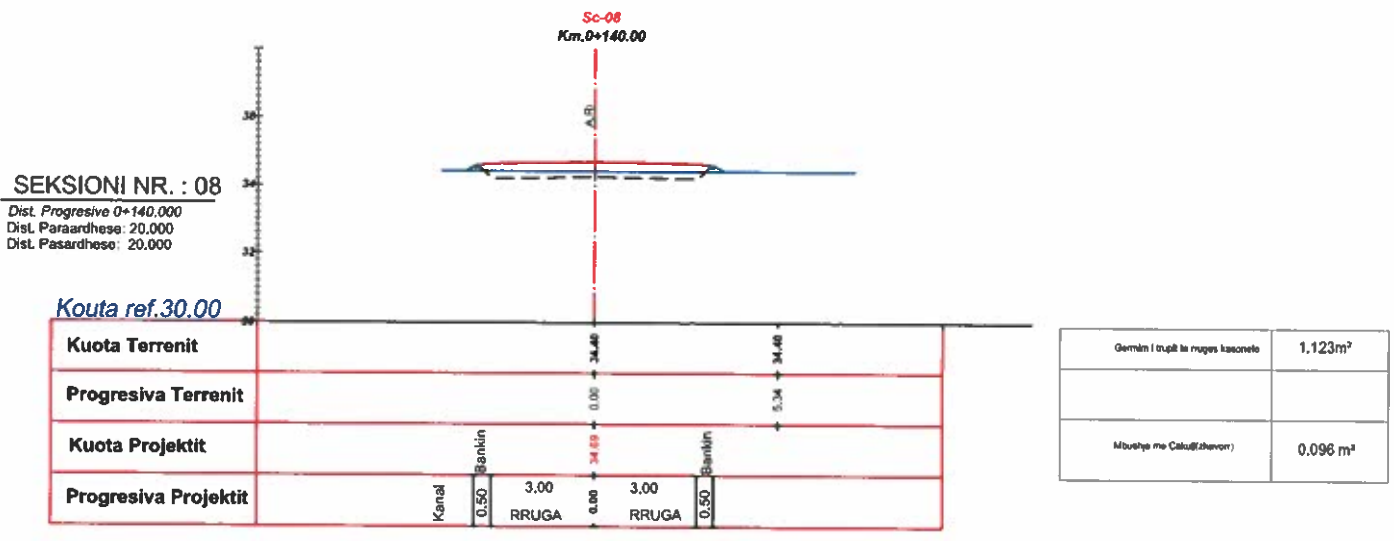
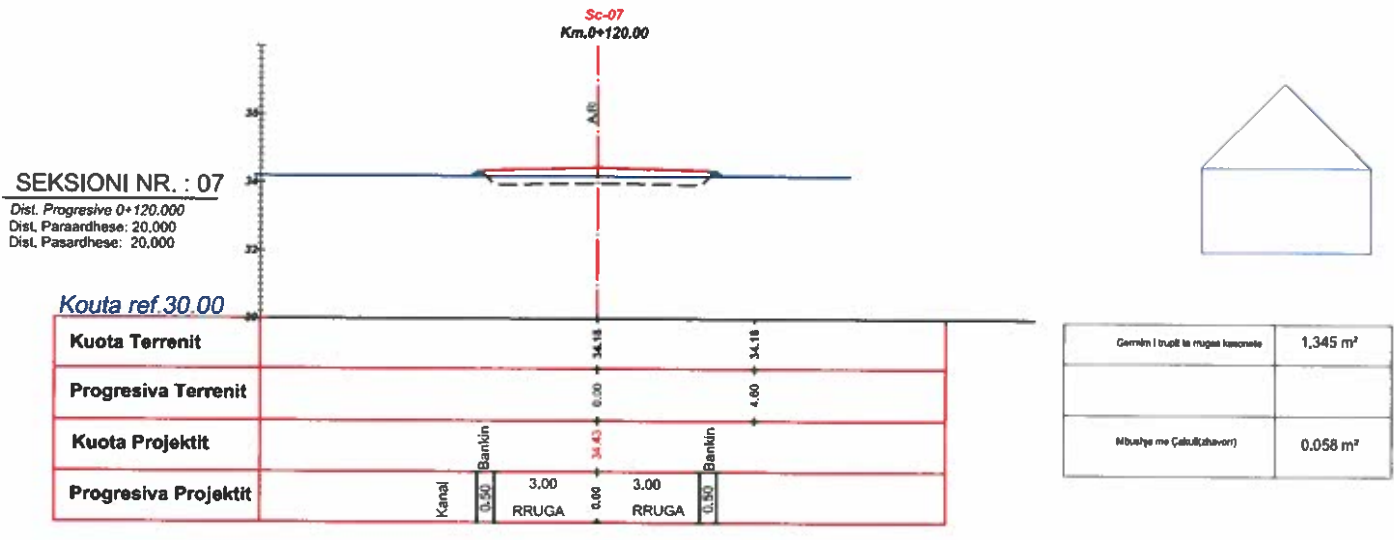

RIKONSTRUKSIONI RRUGES NGA QENDRA DARZEZE - BREGDETE (ANA LINDORE)		FLETA K-23
Proj. Konstruktor	Ing. Haxhi Avdullai	
Proj. Arkitektonek	Ing. Haxhi Avdullai	
Topograf	Ark. Erald TAVANXHIU	
Porosit	Gj. Isidor PRIFTI	
Bashkia FIER(QARKU FIER)		SHKURT 2025 BASHKIA FIER

PROFILAT TERTHOR I SEGMENTIT TE RRUGES QENDER DARZEZE - BREGDETE (PERENDIM) SH.1:100

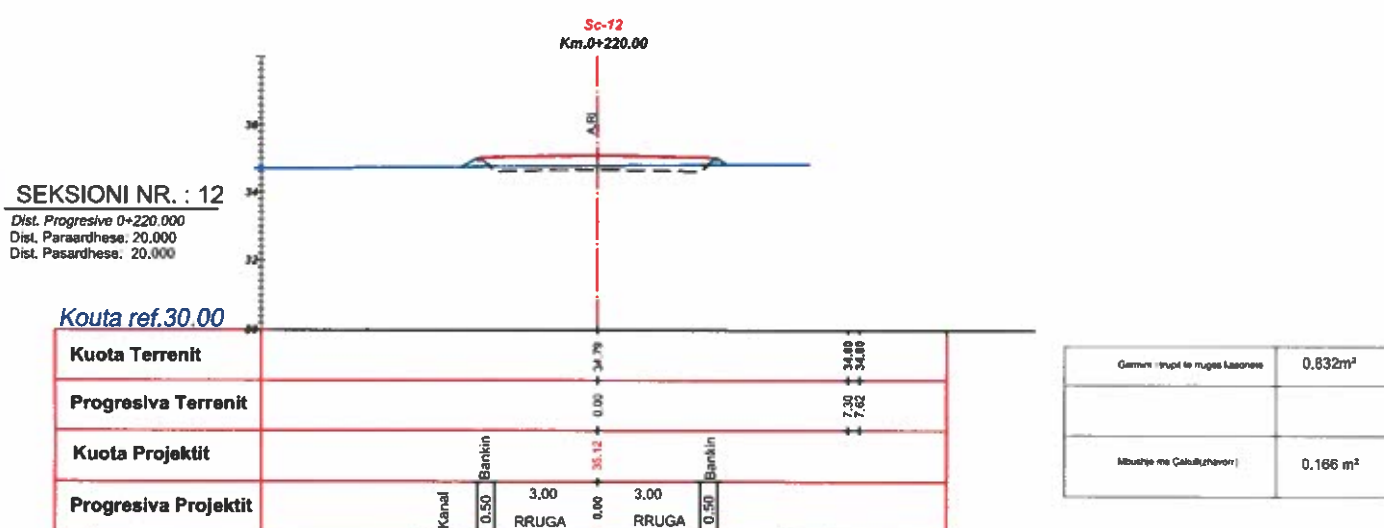
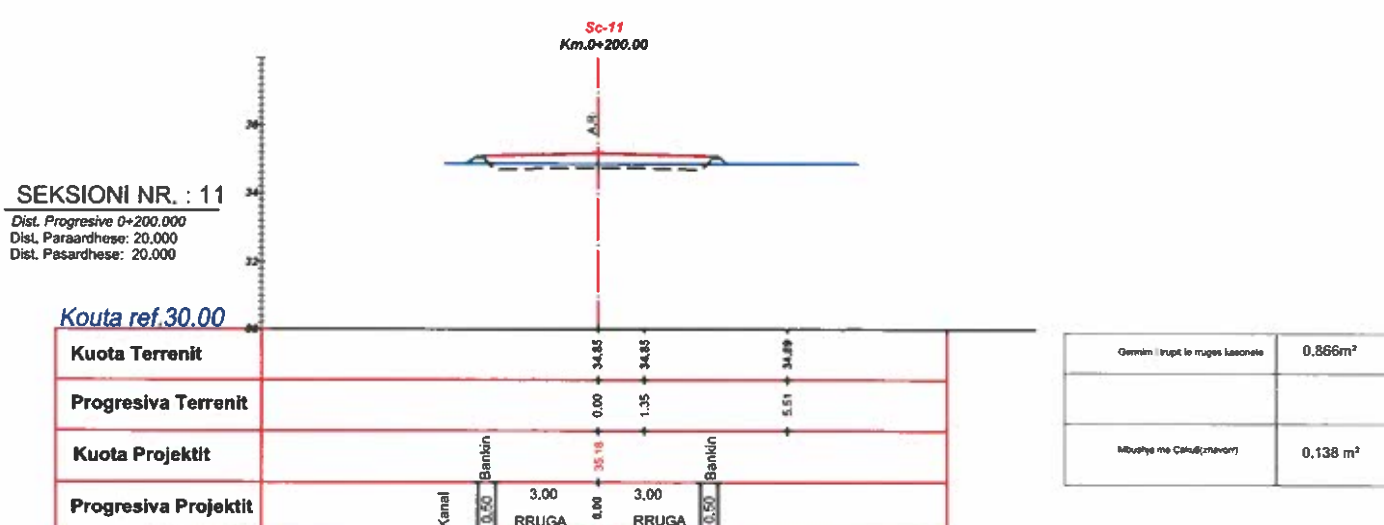
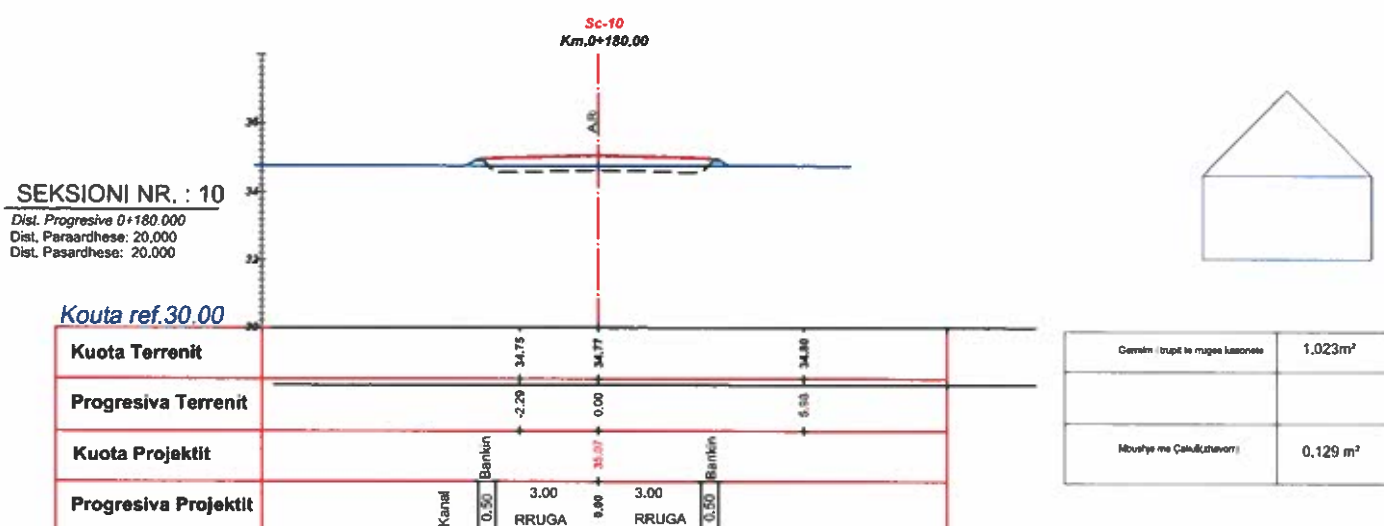

RIKONSTRUKSIONI RRUGES NGA QENDRA DARZEZE - BREGDETE (ANA LINDORE)	FLETA K-24
Drejtori i Punëve të Përgjithshme të Shërbimeve të Përgjithshme të Punëve të Përgjithshme të	Ing. Haxhi Avdullahi
Proj. Konstruktor	Ing. Haxhi Avdullahi
Proj. Arkitektikonik	Ark. Erald TAVANXHIU
Topograf	GJ. Ilisidor PRIFTI
Porositi	Bashkia FIER(QARKU I FIER)
	SHKURT 2025 BASHKIA FIER

PROFILAT TERTHOR I SEGMENTIT TE RRUGES QENDER DARZEZE - BREGDETE (PERENDIM) SH.1:100

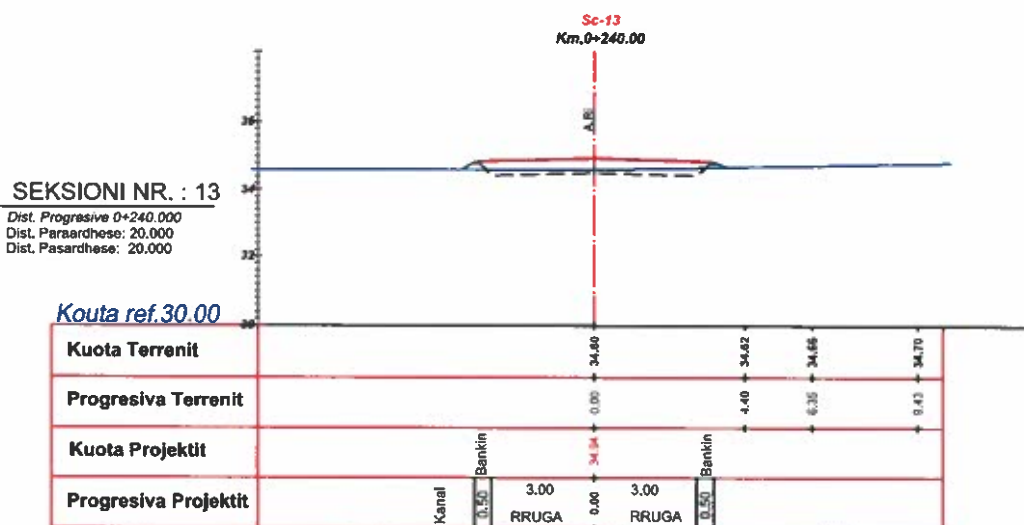

Gjerme i trupit te rruges kasonye	0,871 m ²
Mbushje me Caku(zhevor)	0,141 m ²

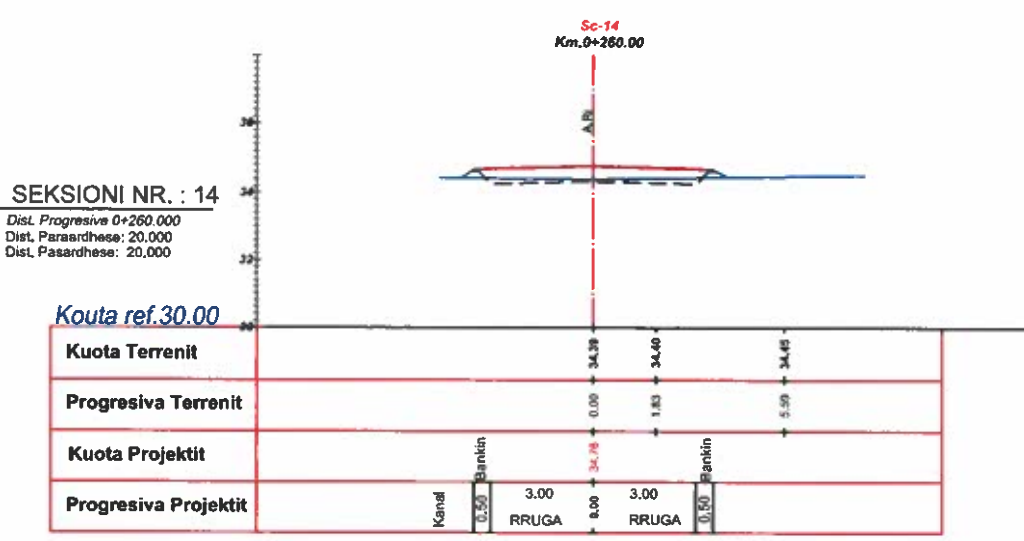

Gjerme i trupit te rruges kasonye	0,693m ²
Mbushje me Caku(zhevor)	0,149 m ²

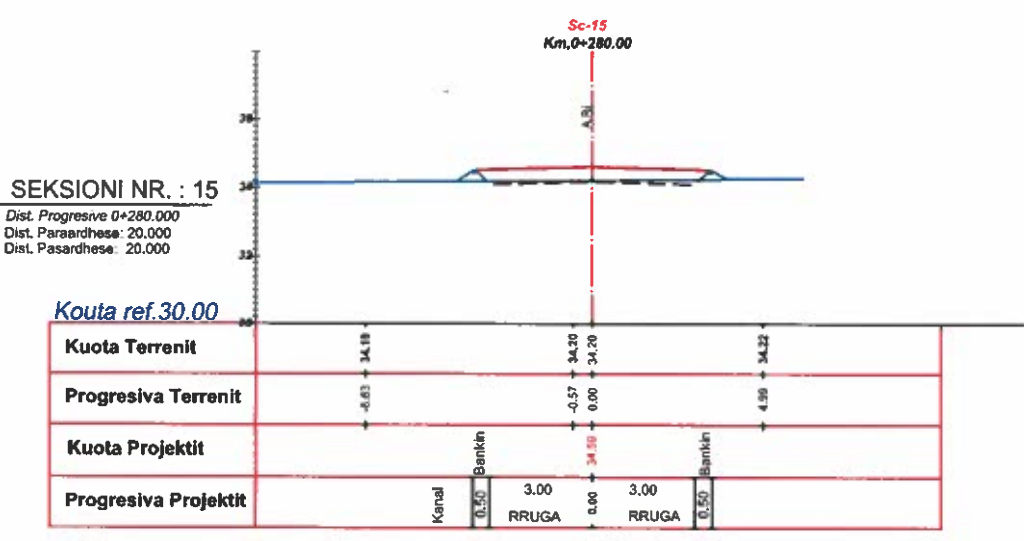

Gjerme i trupit te rruges kasonye	0,456m ²
Mbushje me Caku(zhevor)	0,253 m ²

RIKONSTRUKSIONI RRUGES NGA QENDRA DARZEZE - BREGDETE (ANA LINDORE)		FLETA K-25
PROJ. KONSTRUKTOR	Ing. Haxhi Avdullai	PROFLET TERTHORE (PK13-15)
PROJ. ARKITEKTONIK	Ark. Erald TAVANXHI	
TUPUGRAF	Gj. Isidor PRIFTI	SHKURT 2025
POROSTI	Bashkia FIER(QARRQJENJA)	BASHKIA FIER

**PROFILAT TERTHOR I SEGMENTIT TE RRUGES
QENDER DARZEZE - BREGDETE (PERENDIM) SH.1:100**

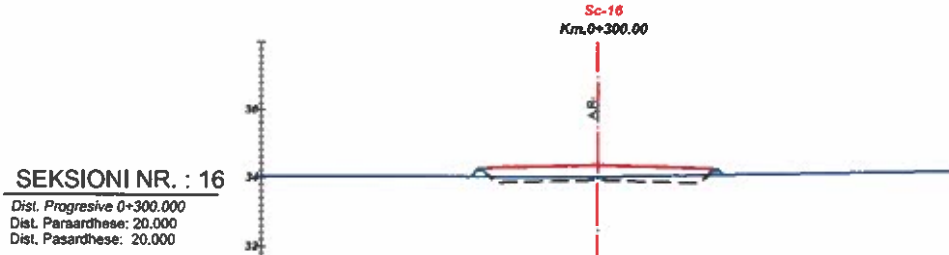

SEKSIONI NR. : 16
Dist. Progressive 0+300.000
Dist. Paraardhese: 20.000
Dist. Pasardhese: 20.000

Kouta ref.30.00

Kuota Terrenit		34.62	34.41	34.08
Progresiva Terrenit		-2.16	0.00	3.00
Kuota Projektit		34.16	34.41	34.00
Progresiva Projektit	Kanal	0.50	0.00	0.50
	Bankin	0.50	0.00	0.50
	RRUGA	3.00	6.00	3.00

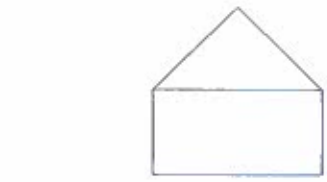

Gjermti i rreptit te rruges kazonote	0.883 m ²
Mbushje me Çakull(zhvron)	0.110 m ²

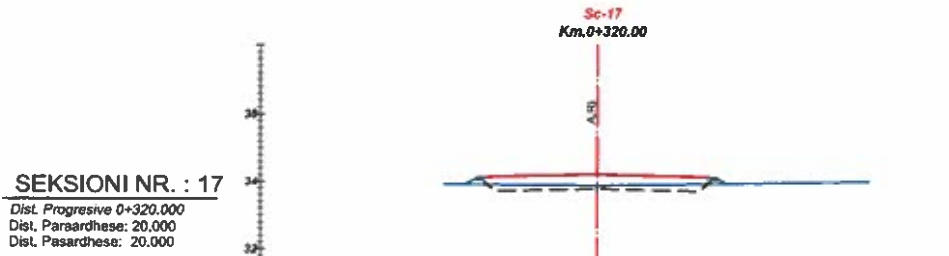

SEKSIONI NR. : 17
Dist. Progressive 0+320.000
Dist. Paraardhese: 20.000
Dist. Pasardhese: 20.000

Kouta ref.30.00

Kuota Terrenit		33.89	34.23	33.90
Progresiva Terrenit		-2.12	0.00	1.33
Kuota Projektit		33.12	34.23	33.33
Progresiva Projektit	Kanal	0.50	0.00	0.50
	Bankin	0.50	0.00	0.50
	RRUGA	3.00	6.00	3.00

Gjermti i rreptit te rruges kazonote	0.948m ²
Mbushje me Çakull(zhvron)	0.116m ²

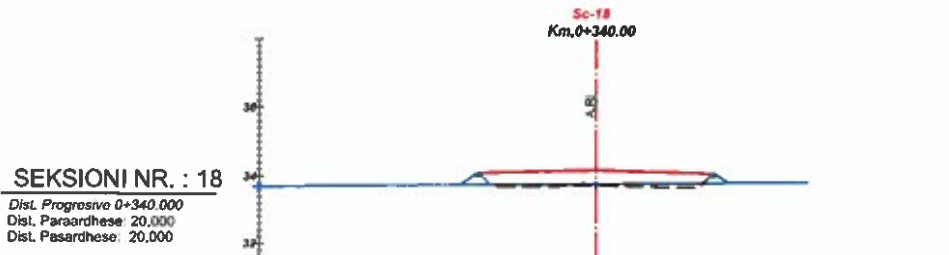

SEKSIONI NR. : 18
Dist. Progressive 0+340.000
Dist. Paraardhese: 20.000
Dist. Pasardhese: 20.000

Kouta ref.30.00

Kuota Terrenit		33.80	34.21	33.81
Progresiva Terrenit		-2.07	0.00	-1.14
Kuota Projektit		32.07	34.21	33.81
Progresiva Projektit	Kanal	0.50	0.00	0.50
	Bankin	0.50	0.00	0.50
	RRUGA	3.00	6.00	3.00

Gjermti i rreptit te rruges kazonote	0.394m ²
Mbushje me Çakull(zhvron)	0.252 m ²

RIKONSTRUKSIONI RRUGES NGA QENDRA DARZEZE - BREGDETE (ANA LINDORE)		PLIETA K-26
Ing. Haxhi Avdullai	Ing. Haxhi Avdullai	PRIFILAT TERTHORE (SH.1:100)
PROJ. KONSTRUKTOR	ARK. ERID TAVANXHIU	
PROJ. ARKITEKTONIK	GJ. ILISIDOR PRIFTI	SHKURT 2025
TOPUGRAF	Bashkia FIER/QARKU FIER	BASHKIA FIER

PROFILAT TERTHOR I SEGMENTIT TE RRUGES QENDER DARZEZE - BREGDETE (PERENDIM) SH.1:100

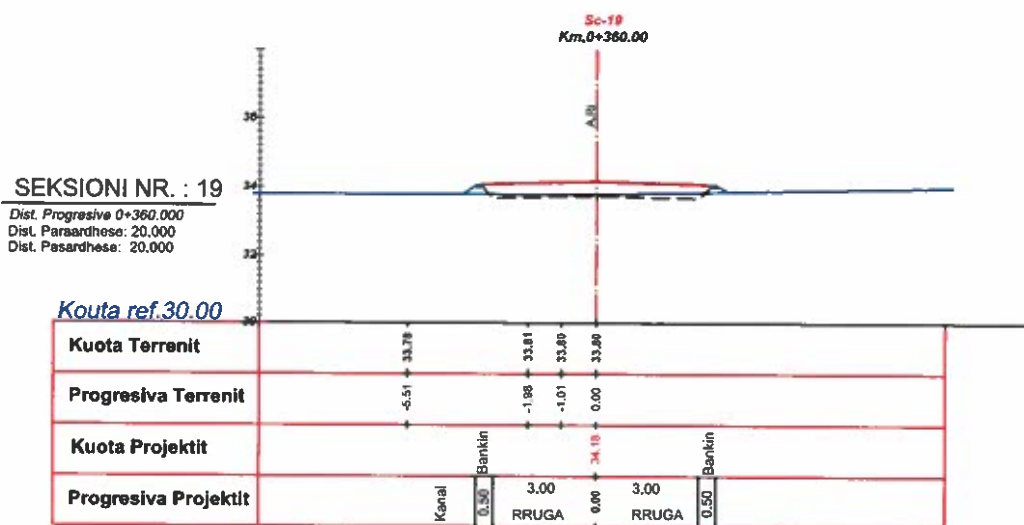

Gjermi i trupit te rruges kasonale	0.617 m ²
Mbushje me Çetull(zhevor)	0.184 m ²

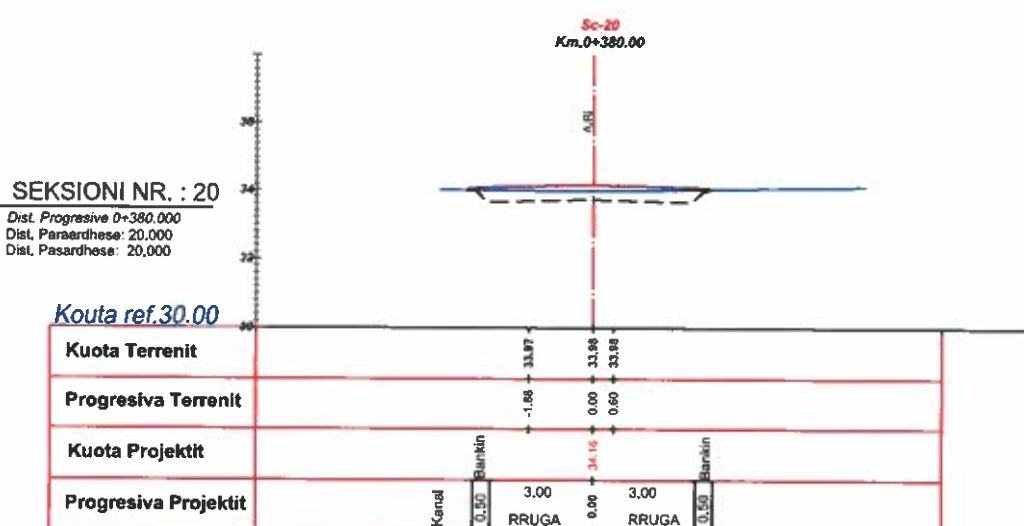

Gjermi i trupit te rruges kasonale	1.926m ²
Mbushje me Çetull(zhevor)	0.115 m ²

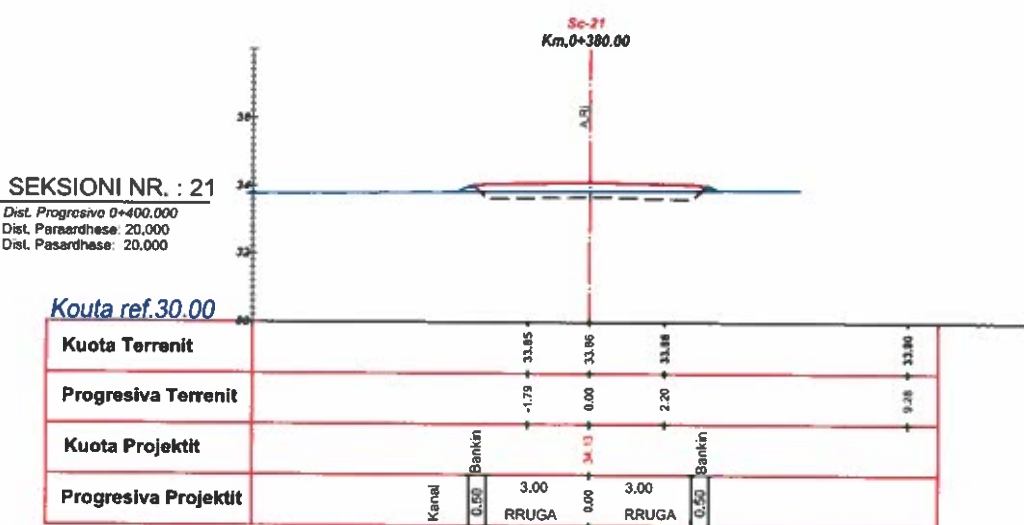

Gjermi i trupit te rruges kasonale	1.219m ²
Mbushje me Çetull(zhevor)	0.096 m ²

RIKONSTRUKSIONI RRUGES NGA QENDRA DARZEZE - BREGDETE (ANA LINDORE)		FLETA K-27	
PROJEKTUESI I PËRMBUESITIA TË PËR QYEMINTE BIZ	Ing.	Haxhi Avdullai	
PROJ. KONSTRUKTOR	Ing.	Haxhi Avdullai	
PROJ. ARKITEKTONIK	Ark.	Erald TAVANXHIU	
TOPOGRAF	G.J.	Ilsidor PRIFTI	SHKURT 2025
FOROSIT	Bashkia FIER(QARKU FIER)		BASHKIA FIER

**PROFILAT TERTHOR I SEGMENTIT TE RRUGES
QENDER DARZEZE - BREGDETE (PERENDIM) SH.1:100**

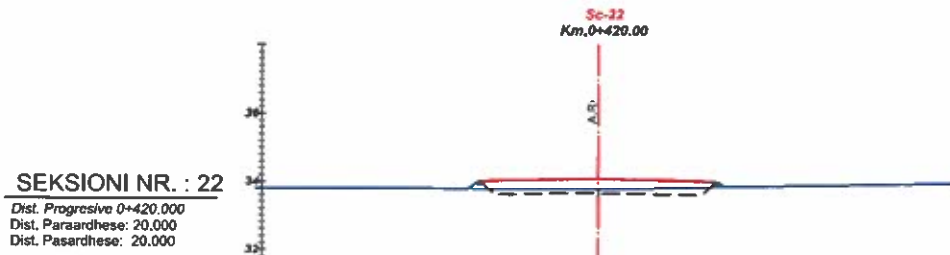

SEKSIONI NR. : 22
Dist. Progressive 0+420.000
Dist. Parardhese: 20.000
Dist. Pasardhese: 20.000

Kouta ref.30.00

Kuota Terrenit		33.81	33.81	33.82	33.85
Progresiva Terrenit		-1.69	0.00	3.81	0.98
Kuota Projektit		34.11	34.11	34.12	34.15
Progresiva Projektit	Kanal	0.50	3.00 RRUGA	3.00 RRUGA	0.50



Gjerme i trupit te rruges tekonstrate	1.128 m ²
Mbushje me Çetull(zhvorr)	0.083 m ²

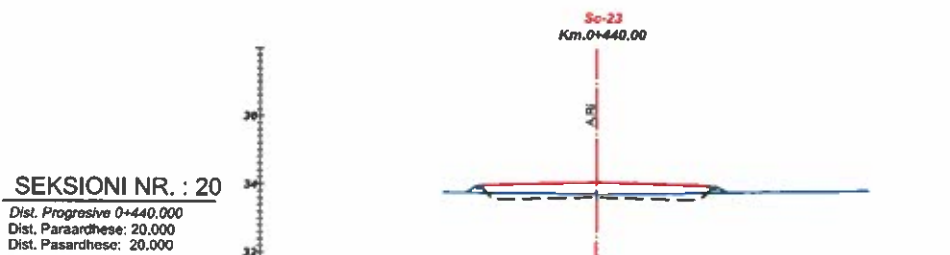

SEKSIONI NR. : 20
Dist. Progressive 0+440.000
Dist. Parardhese: 20.000
Dist. Pasardhese: 20.000

Kouta ref.30.00

Kuota Terrenit		33.75	33.75	33.78	
Progresiva Terrenit		0.00	0.34	3.32	
Kuota Projektit		34.05	34.05	34.10	
Progresiva Projektit	Kanal	0.50	3.00 RRUGA	3.00 RRUGA	0.50

Gjerme i trupit te rruges tekonstrate	0.948 m ²
Mbushje me Çetull(zhvorr)	0.112 m ²

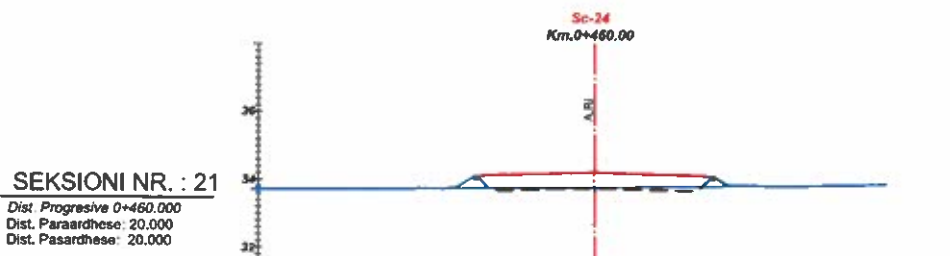

SEKSIONI NR. : 21
Dist. Progressive 0+460.000
Dist. Parardhese: 20.000
Dist. Pasardhese: 20.000

Kouta ref.30.00

Kuota Terrenit		33.81	33.81	33.58	33.58
Progresiva Terrenit		0.00	0.00	4.50	7.83
Kuota Projektit		34.21	34.21	34.21	34.21
Progresiva Projektit	Kanal	0.50	3.00 RRUGA	3.00 RRUGA	0.50

Gjerme i trupit te rruges tekonstrate	0.394 m ²
Mbushje me Çetull(zhvorr)	0.277 m ²

		RIKONSTRUKSIONI RRUGES NGA QENDRA DARZEZE - BREGDETE (ANA LINDORE)		PLANI K-28
		Ing. Haxhi Avdullai PROJ. KONSTRUKTOR	Ing. Haxhi Avdullai PROJ. ARKITEKTONIK	Ark. Fraid TAVANXHIU TOPKORAP
		Bashkia FIER(QARKU FIER)		BASHKIA FIER

PROFILAT TERTHOR I SEGMENTIT TE RRUGES QENDER DARZEZE - BREGDETE (PERENDIM) SH.1:100

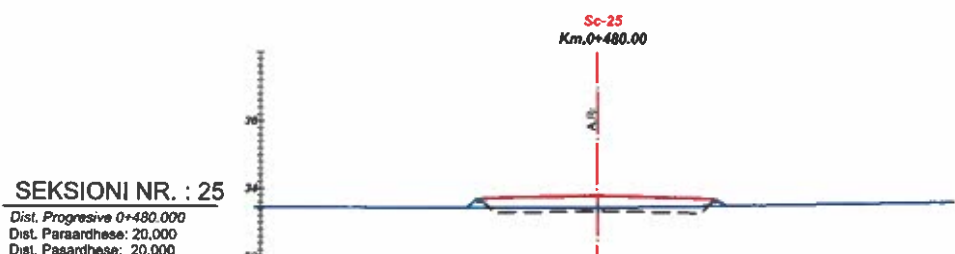

SEKSIONI NR. : 25
Dist. Progressive 0+480.000
Dist. Paraardhese: 20.000
Dist. Pasardhese: 20.000

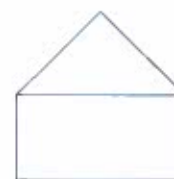

Kouta ref.30.00

Kuota Terrenit	33.43	33.45	33.48
Progresiva Terrenit	-4.51	0.00	7.83
Kuota Projektit	33.60	33.60	33.60
Progresiva Projektit	Kanal 0.50	3.00 RRUGA	3.00 RRUGA 0.50 Bankin

Gjenerim i trupit te rruges kasonate	0.807m ²
Mbledhje me Çatull(zhevor)	0.137 m ²

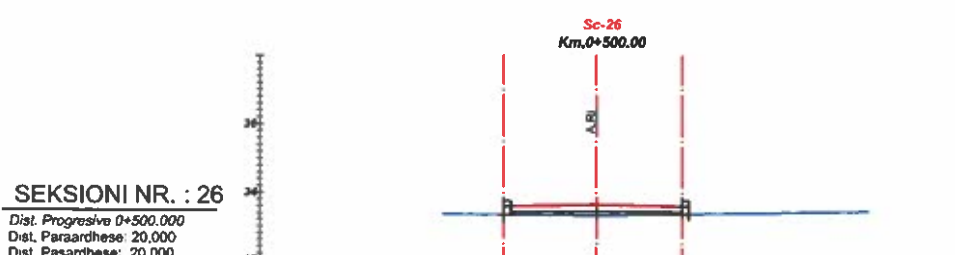

SEKSIONI NR. : 26
Dist. Progressive 0+500.000
Dist. Paraardhese: 20.000
Dist. Pasardhese: 20.000

Kouta ref.30.00

Kuota Terrenit	33.34	33.34	33.34
Progresiva Terrenit	-2.12	0.00	1.13
Kuota Projektit	33.65	33.65	33.65
Progresiva Projektit	2.5 Bordur/kiz	0.00 RRUGA	2.5 Bordur/kiz

Gjenerim i trupit te rruges kasonate	0.00m ²
Mbledhje me Çatull(zhevor)	0.00 m ²

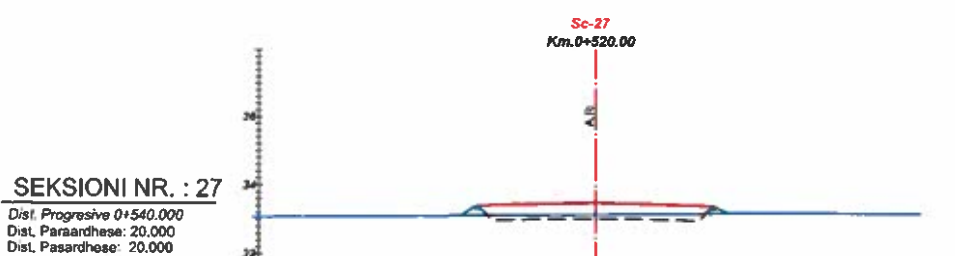

SEKSIONI NR. : 27
Dist. Progressive 0+540.000
Dist. Paraardhese: 20.000
Dist. Pasardhese: 20.000

Kouta ref.30.00

Kuota Terrenit	33.16	33.18	33.22
Progresiva Terrenit	-5.22	0.00	8.04
Kuota Projektit	33.61	33.61	33.61
Progresiva Projektit	Kanal 0.50	3.00 RRUGA	3.00 RRUGA 0.50 Bankin

Gjenerim i trupit te rruges kasonate	0.833m ²
Mbledhje me Çatull(zhevor)	0.170 m ²

REKONSTRUKSIONI RRUGES NGA QENDRA DARZEZE - BREGDETE (AMA LINDORE)		K-29
Proj. Konstruktore	Ing. Haxhi Avdullai	
Proj. Analizues	Ark. Enah TAVANKXITU	
Topografi	G.J. Ilidori PRIFTI	
Porositi	Bashkia FIERQARKU FIER	
<small>PROJEKT 2025</small>		<small>SHKËMBIM</small>

PROFILAT TERTHOR I SEGMENTIT TE RRUGES QENDER DARZEZE - BREGDETE (PERENDIM) SH.1:100

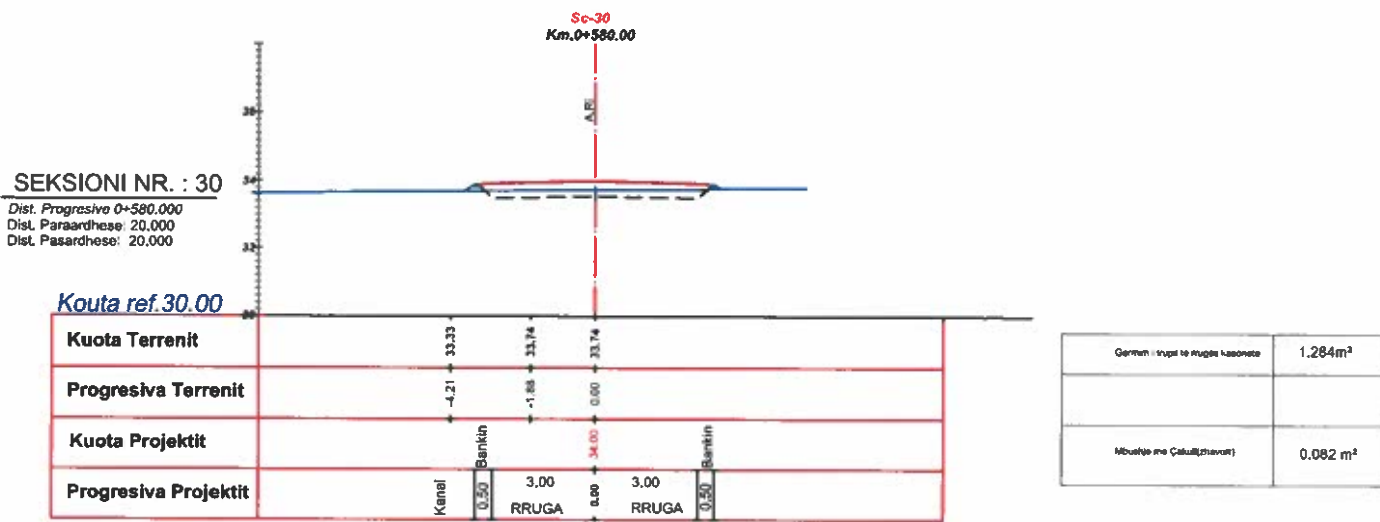
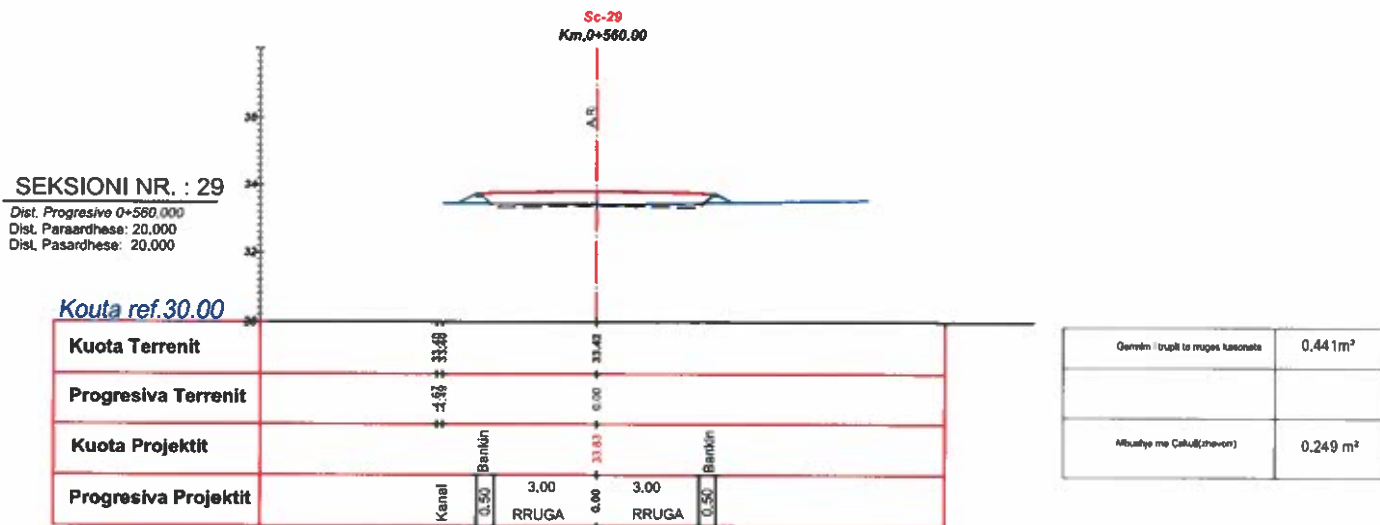
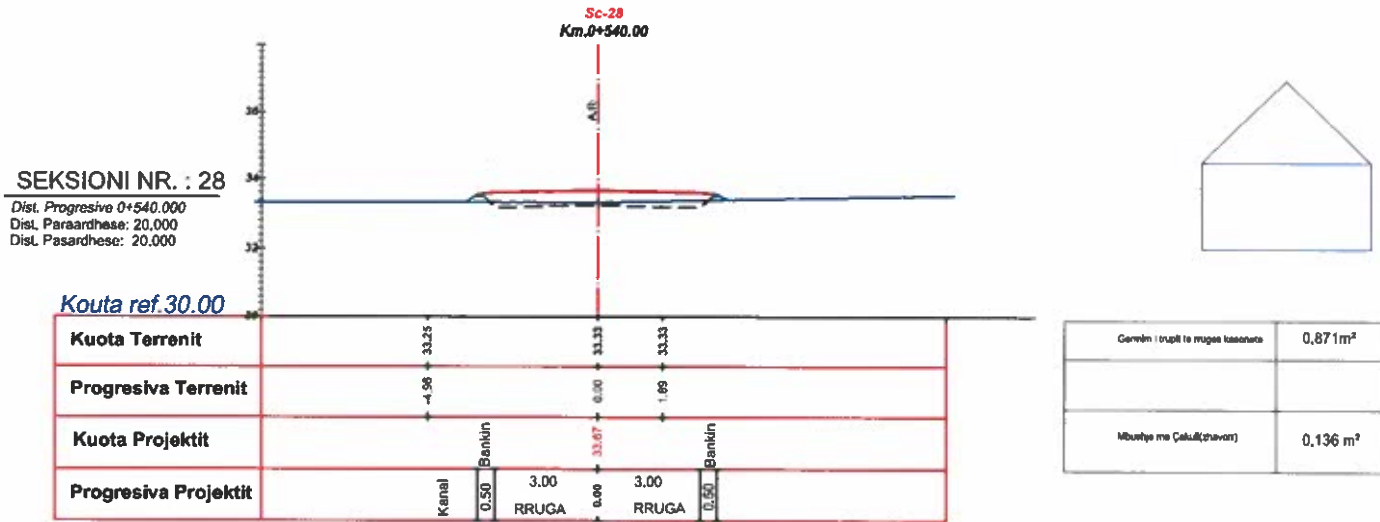

	RIKONSTRUKSIONI RRUGOR NGA QENDRA DARZEZE - BREGDETE (ANA LINDORE)	QISETA PK-30
Drejtori i Punëve të Përgjithshme të Bashkisë së Fierit	Ing. Haxhi Avdullai	
Proj. Konstruktor	Ing. Haxhi Avdullai	
Proj. Arkitektikonik	Ark. Enkid TAVANXHIU	
TOPOGRAF	Gj. Ilisidor PRIFTI	
Porositi	Bashkia FIER(QARKU FIER)	
		SHKURT 2025 BASHKIA FIER

**PROFILAT TERTHOR I SEGMENTIT TE RRUGES
QENDER DARZEZE - BREGDETE (PERENDIM) SH.1:100**

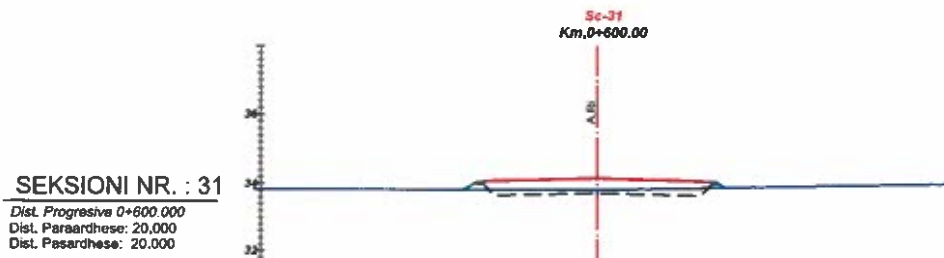

Kouta ref.30.00

Kuota Terrenit		33.86	33.84	33.84	33.86
Progresiva Terrenit		-3.53	0.00	0.95	10.00
Kuota Projektit			34.17		
Progresiva Projektit	Kanal	0.50	3.00	3.00	0.50
		Bankin	RRUGA	RRUGA	Bankin

Gjeremi i trupit te rruges kazonete	0.935 m ²
Mbushje me Çetull(zhavror)	0.123 m ²

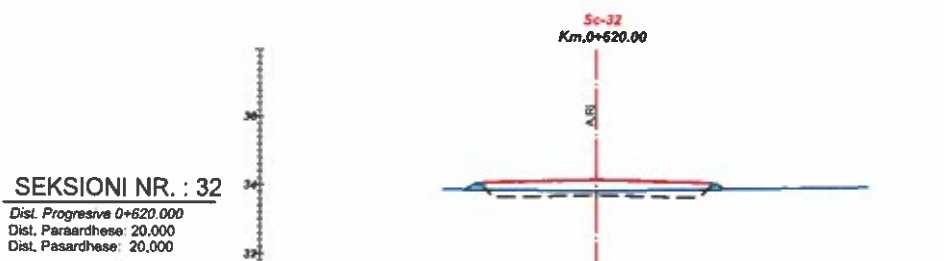

Kouta ref.30.00

Kuota Terrenit		33.88	33.85	33.88	33.94
Progresiva Terrenit		-2.81	0.00	3.92	9.43
Kuota Projektit			34.168		
Progresiva Projektit	Kanal	0.50	3.00	3.00	0.50
		Bankin	RRUGA	RRUGA	Bankin

Gjeremi i trupit te rruges kazonete	1.025m ²
Mbushje me Çetull(zhavror)	0.105 m ²

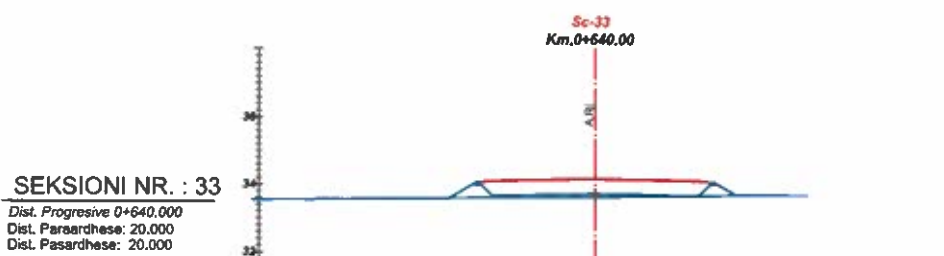

Kouta ref.30.00

Kuota Terrenit		33.83	33.83	33.84	33.85
Progresiva Terrenit		-4.83	-3.41	0.00	6.03
Kuota Projektit				34.168	
Progresiva Projektit	Kanal	0.50	3.00	3.00	0.50
		Bankin	RRUGA	RRUGA	Bankin

Gjeremi i trupit te rruges kazonete	0.00m ²
Mbushje me Çetull(zhavror)	0.906 m ²

	RIKONSTRUKSIONI RRUGES NGA QENDRA DARZEZE - BREGDETE (ANA LINDORE)		FLETA 31
	Proj. Konstruktor	Ing. Haxhi Avdullai	
	Proj. Arkitektomik	Ark. Enald TAVANXHIU	
	TUPOGRAF	Gj. Ilisidor PRIFTI	
	PROSITI	Bashkia FIER(QARKU FIER)	
		PRORJETI TERRENORE (SKL.31-33) SHKURT 2025 BASHKIA FIER	

**PROFILAT TERTHOR I SEGMENTIT TE RRUGES
QENDER DARZEZE - BREGDETE (PERENDIM) SH.1:100**

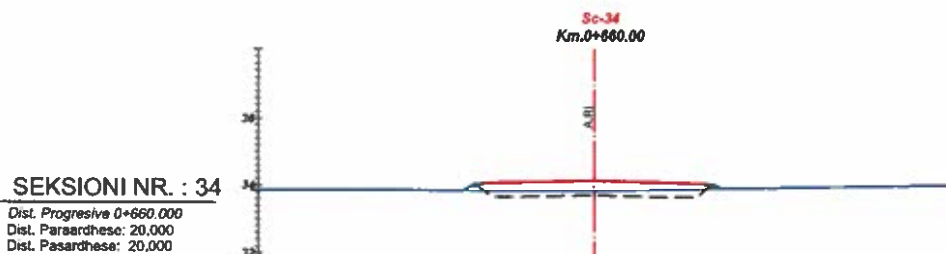

SEKSIONI NR. : 34
Dist. Progressive 0+660.000
Dist. Pasaardhese: 20.000
Dist. Pasardhese: 20.000



Kouta ref.30.00

Kuota Terrenit	33.88	33.84	33.88	33.84
Progresiva Terrenit	-4.55	-3.74	0.00	5.80
Kuota Projektit				
Progresiva Projektit	Kanal 0.50	Bankin 3.00	RRUGA 0.00	Bankin 3.00

Gjermi i trupit te rruges kazonete	1.102 m ²
Mbulimje me Çetull(zhvorr)	0.096 m ²

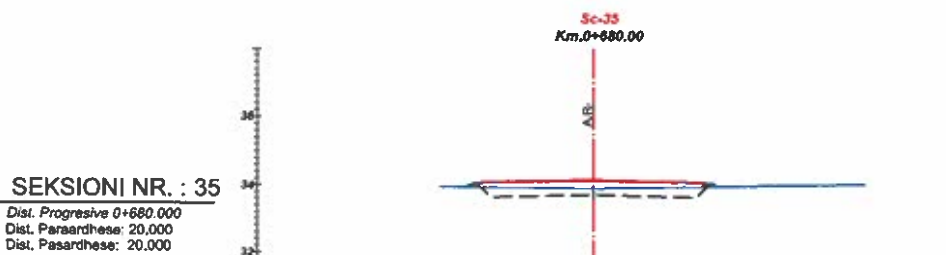

SEKSIONI NR. : 35
Dist. Progressive 0+680.000
Dist. Pasaardhese: 20.000
Dist. Pasardhese: 20.000

Kouta ref.30.00

Kuota Terrenit	33.96	33.88	33.96	33.96
Progresiva Terrenit	-5.87	0.00	0.00	4.08
Kuota Projektit				
Progresiva Projektit	Kanal 0.50	Bankin 3.00	RRUGA 0.00	Bankin 3.00

Gjermi i trupit te rruges kazonete	1.587 m ²
Mbulimje me Çetull(zhvorr)	0.025 m ²

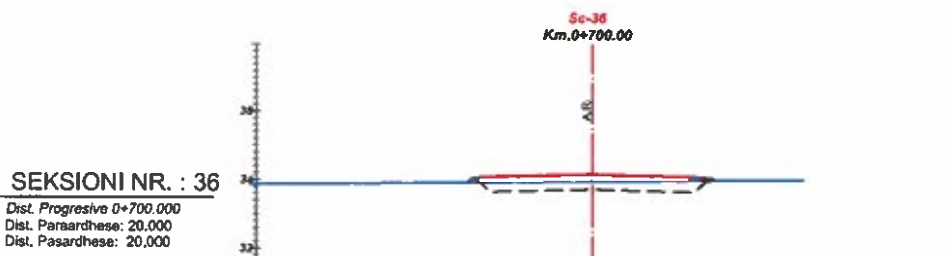

SEKSIONI NR. : 36
Dist. Progressive 0+700.000
Dist. Pasaardhese: 20.000
Dist. Pasardhese: 20.000

Kouta ref.30.00

Kuota Terrenit	33.96	33.96	33.96	33.96
Progresiva Terrenit	-6.15	0.00	0.00	4.00
Kuota Projektit				
Progresiva Projektit	Kanal 0.50	Bankin 3.00	RRUGA 0.00	Bankin 3.00

Gjermi i trupit te rruges kazonete	1.678 m ²
Mbulimje me Çetull(zhvorr)	0.028 m ²

RIKONSTRUKSIONI RRUGES NGA QENDRA DARZEZE - BREGDETE (ANA LINDORE)		PLANA R-32
Proj. Konstruktor	Ing. Haxhi Avdullai	PRORRIETETI TERTHOR (R-34-36)
Proj. ARKITEKTONIK	Ing. Haxhi Avdullai	
TUPOGRAF	Ark. Erald TAVANXHIU	KURT 2025
POROSITI	Gj. Ilisidor PRIFTI	
Bashkia FIER(QARKU FIER)		BASHKIA FIER

PROFILAT TERTHOR I SEGMENTIT TE RRUGES QENDER DARZEZE - BREGDETE (PERENDIM) SH.1:100

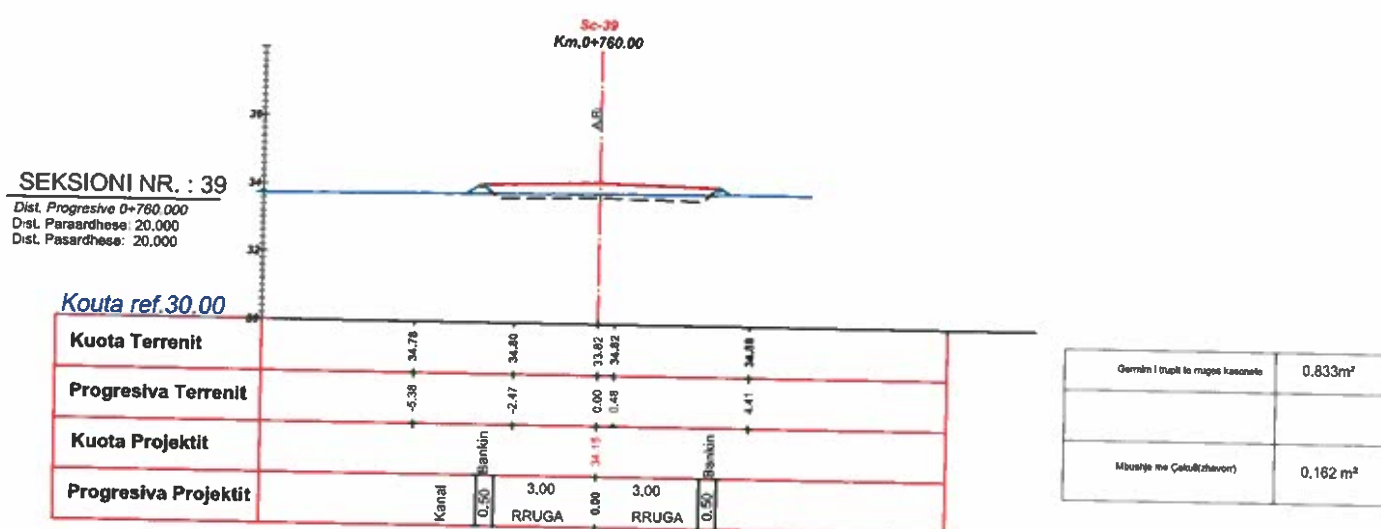
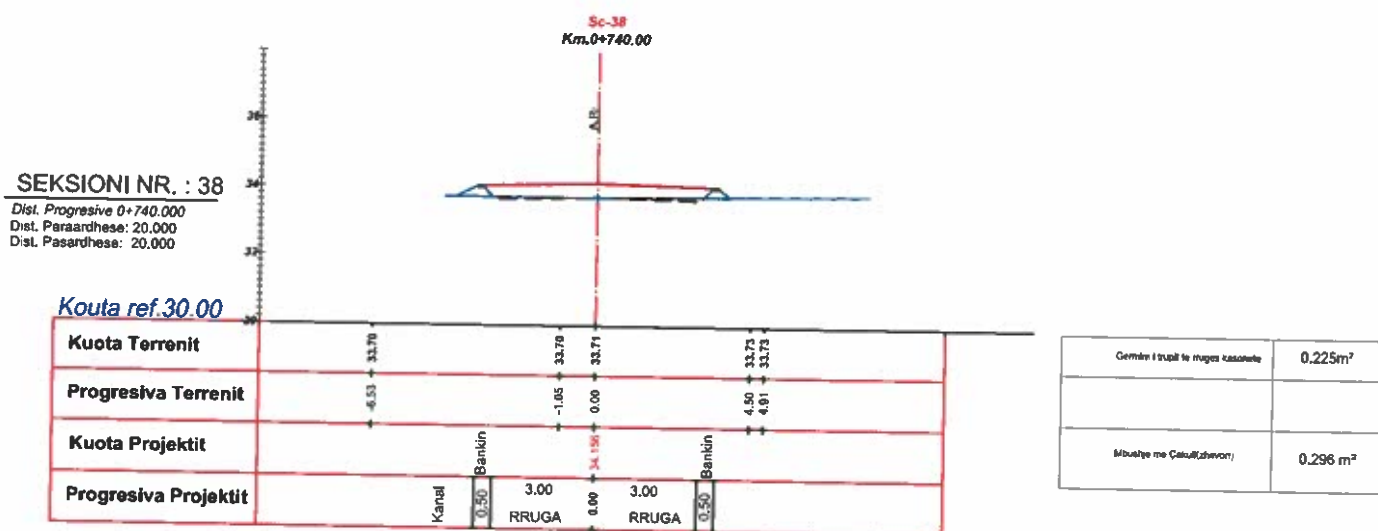
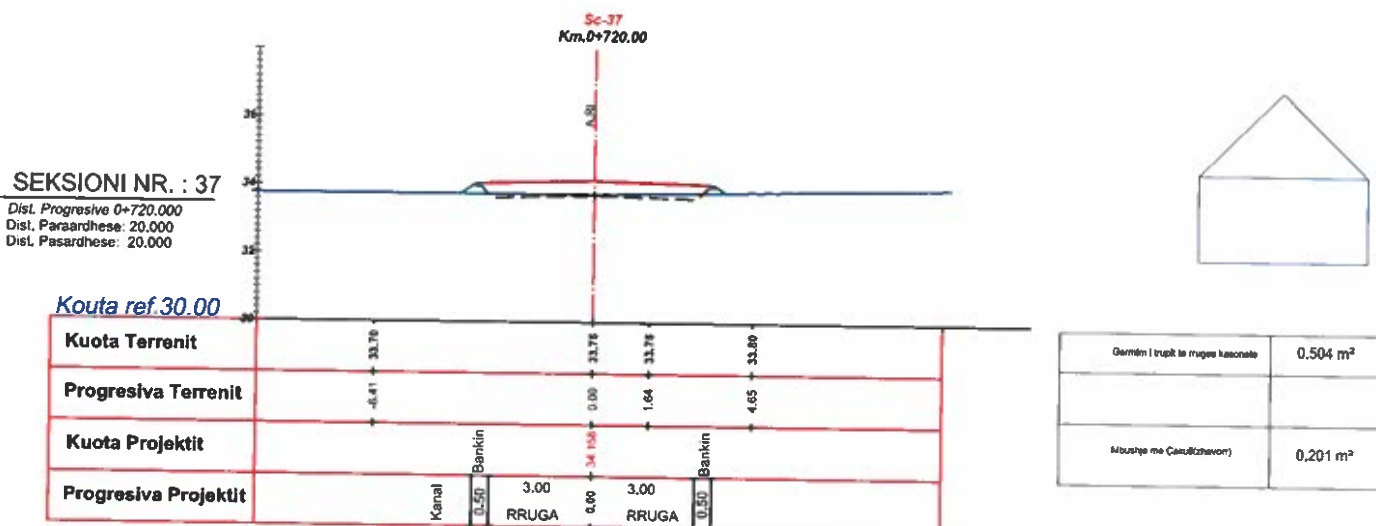

RIKONSTRUKSIONI RRUGES NGA QENDRA DARZEZE - BREGDETE (ANA LINDORE)		PRIPA K-33
<small>DEKLARIMET E PËRMBUESIT TË KËNAQËSISË</small>	Ing. Haxhi Avdullai	
PROJ. KONSTRUKTOR	Ing. Haxhi Avdullai	
PROJ. ARKITEKTONIK	Ark. Erajd TAVANXHIU	
TOPOGRAF	G.J. Ihsidor PRIFTI	
POKOSITI	Bashkia FIER(QARKU FIER)	
		<small>PROJEKTI TERRITORE (PNC.27-38)</small> <small>2007 2025</small> BASHKIA FIER

PROFILAT TERTHOR I SEGMENTIT TE RRUGES QENDER DARZEZE - BREGDETE (ANA LINDORE) SH.1:100

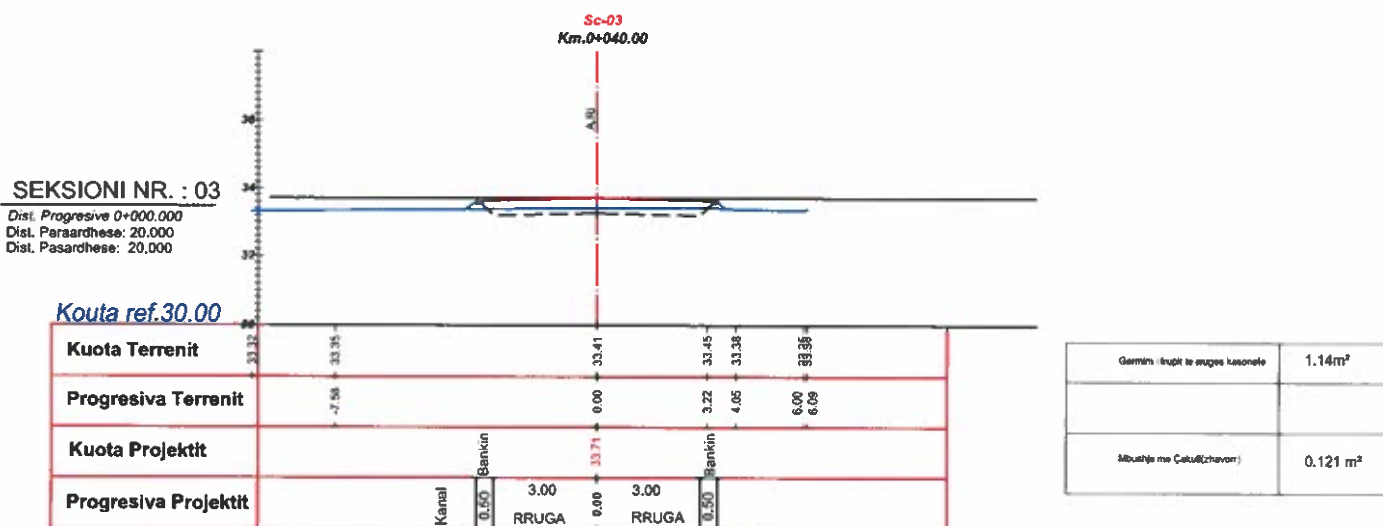
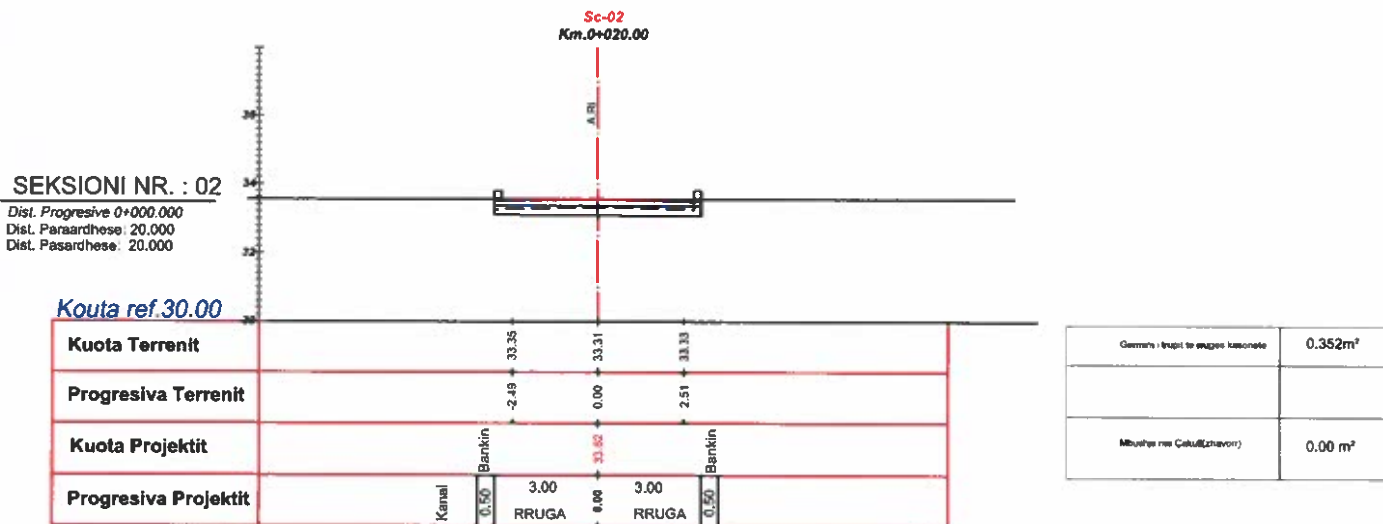
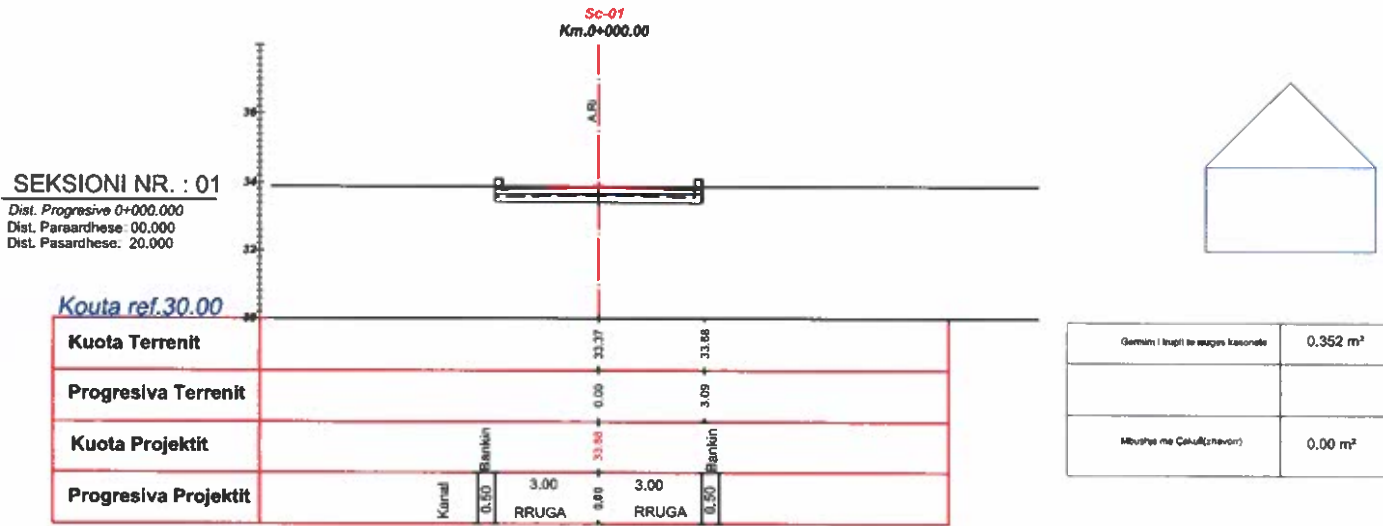

RIKONSTRUKSIONI RRUGES NGA QENDRA DARZEZE - BREGDETE (ANA LINDORE)		PLETA K-31
DEPARTIMETI I INZHINIERISIAE DHE INZHINIERIJA E CIVILE	Ing.	Haxhi Avdullai
PROJ. Konstruktor	Ing.	Haxhi Avdullai
PROJ. ARKITEKTONIK	Ark.	Enid TAVANXHIU
TOPOGRAFI	GJ.	Iludor PRIFTI
POKOSIT	Bashkia FIER(QARKU FIER)	
		PRILET TERTHORE (PKL01-03) SHKURT 2025 BASHKIA FIER

PROFILAT TERTHOR I SEGMENTIT TE RRUGES QENDER DARZEZE - BREGDETE (ANA LINDORE) SH.1:100

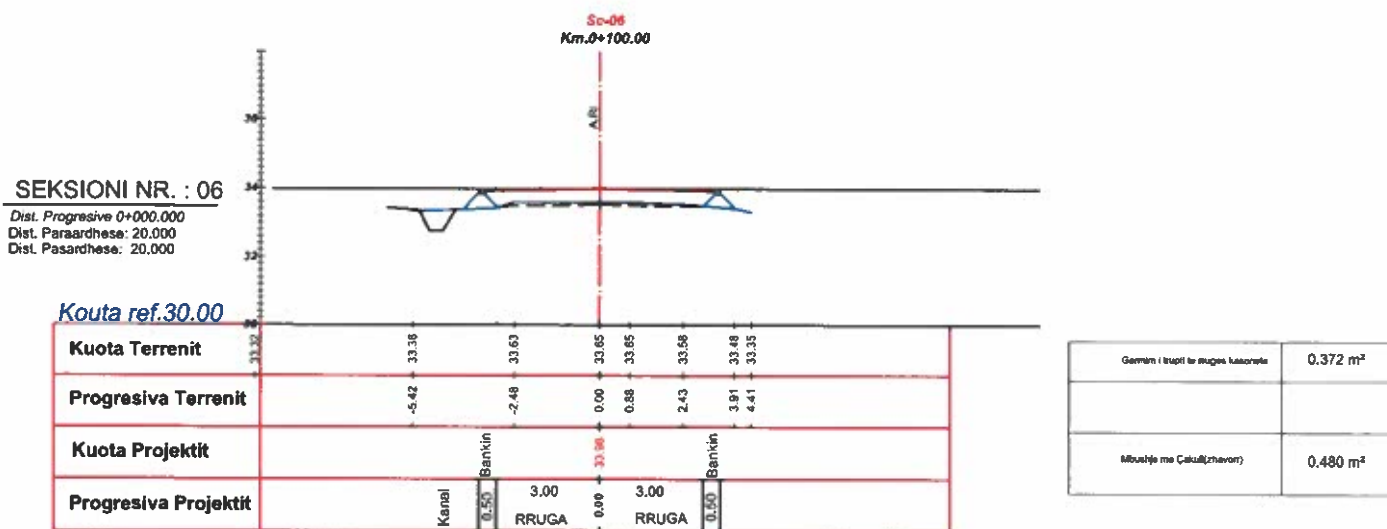
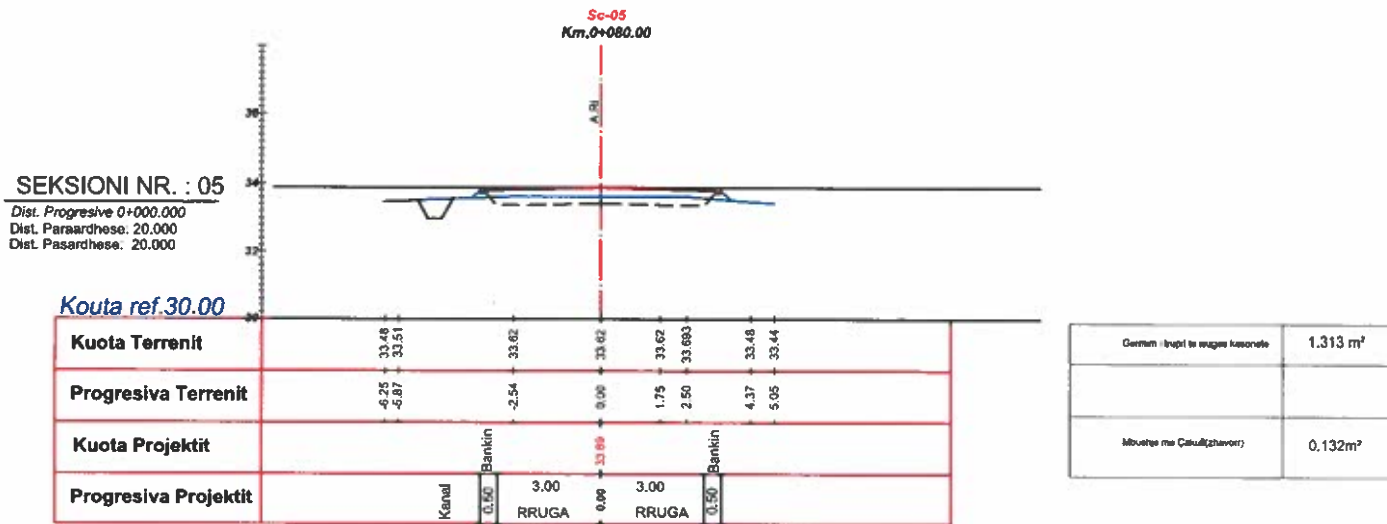
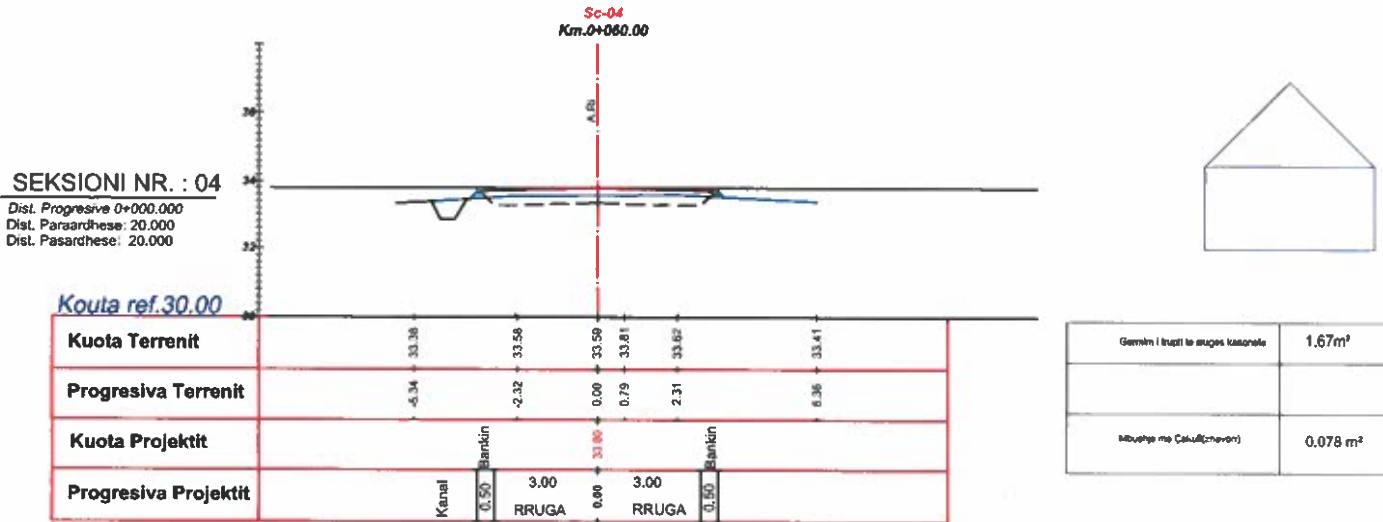

	RIKONSTRUKSIONI RRUGES NGA QENDRA DARZEZE - BREGDETE (ANA LINDORE)	FLETA -32
PRUJ. KONSTRUKTOR	Ing. Haxhi Avdullahi	PRUJ. ARKITEKTONIK
PRUJ. ARKITEKTONIK	Ing. Haxhi Avdullahi	TOPOGRAF
TOPOGRAF	Ark. Enid TAVANXHIU	POROSIT
POROSIT	Gj. Iludor PRIFTI	Bashkia FIER(QARKU FIER)
Bashkia FIER(QARKU FIER)		BASHKIA FIER

PROFILAT TERTHORI I SEGMENTIT TE RRUGES QENDER DARZEZE - BREGDETE (ANA LINDORE) SH.1:100

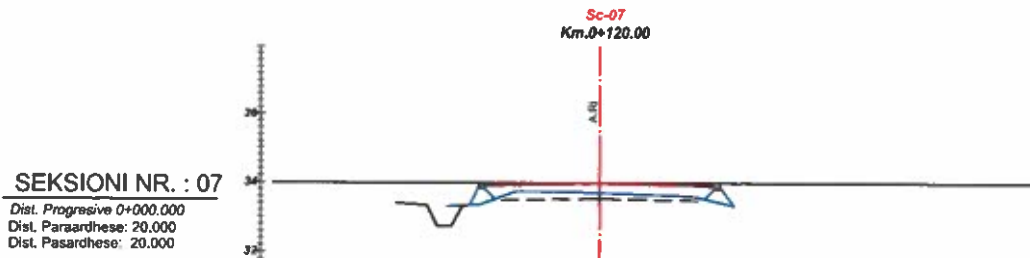

SEKSIONI NR. : 07
Dist. Progressive 0+000.000
Dist. Paraardhese: 20.000
Dist. Pasardhese: 20.000

Kuota ref.30.00

Kuota Terrenit		33.32	33.35	33.74	33.74	33.70	33.63	33.59	33.53
Progresiva Terrenit		-4.41	-3.52	-2.44	-1.22	0.00	2.26	2.80	3.92
Kuota Projektit						33.996			
Progresiva Projektit	Kanali	0.50	Bankin	3.00	RRUGA	0.00	RRUGA	0.50	Bankin

Gjerimi i trupit te magjes kasonale	1.057 m ²
Mbushja me Caku(zhavor)	0.411m ²

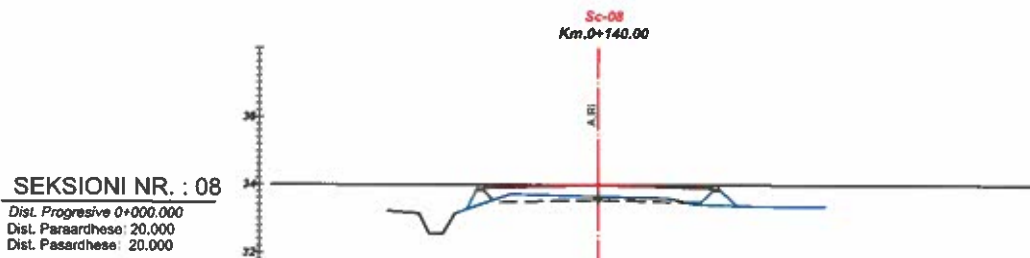

SEKSIONI NR. : 08
Dist. Progressive 0+000.000
Dist. Paraardhese: 20.000
Dist. Pasardhese: 20.000

Kuota ref.30.00

Kuota Terrenit		33.45	33.73	33.65	33.61	33.42	33.36	33.35	33.34
Progresiva Terrenit		-3.31	-2.54	0.00	1.99	2.82	4.57	5.08	6.57
Kuota Projektit				33.996					
Progresiva Projektit	Kanali	0.50	Bankin	3.00	RRUGA	0.00	RRUGA	0.50	Bankin

Gjerimi i trupit te magjes kasonale	0.725 m ²
Mbushja me Caku(zhavor)	0.515 m ²

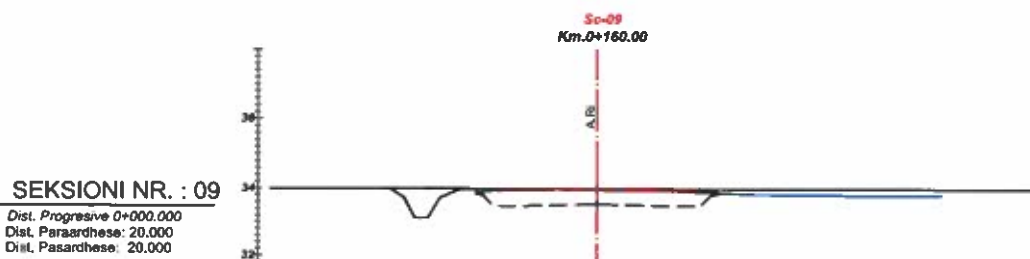

SEKSIONI NR. : 09
Dist. Progressive 0+000.000
Dist. Paraardhese: 20.000
Dist. Pasardhese: 20.000

Kuota ref.30.00

Kuota Terrenit		33.32	34.00	33.96	33.94	33.93	33.94	33.79	33.81
Progresiva Terrenit			-2.05	0.00	0.74	2.05	4.86	7.95	10.80
Kuota Projektit				33.996					
Progresiva Projektit	Kanali	0.50	Bankin	3.00	RRUGA	0.00	RRUGA	0.50	Bankin

Gjerimi i trupit te magjes kasonale	2.827 m ²
Mbushja me Caku(zhavor)	0.000 m ²

REKONSTRUKSIONI RRUGES NGA QENDRA DARZEZE - BREGDETE (ANA LINDORE)		FLETA K-33
DIREKTOR I PUNES NE PROJEKTIM E P. INZHINIERI TERA	Ing.	Haxhi Avdullai
PRIN KONSTRUKTOR	Ing.	Haxhi Avdullai
PROJ. ARKITEKTONIK	Ark.	Enald TAVANXHIU
TOPOGRAF	GJ.	Isidor PRIFTI
PROJEKTI	Bashkia FIER(QARKU FIER)	
		PRILET TERTHORE (14.07-08) SHKURT 2025 BASHKIA FIER

PROFILAT TERTHOR I SEGMENTIT TE RRUGES QENDER DARZEZE - BREGDETE (ANA LINDORE) SH.1:100

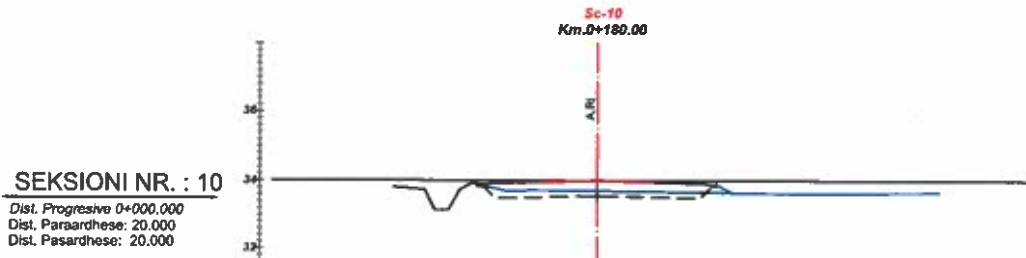

Kouta ref.30.00

Kuota Terrenit		33.70	33.73	33.71	33.70	33.64	33.67
Progresiva Terrenit		-2.24	-1.86	0.00	1.72	5.97	12.90
Kuota Projektit		3.00	3.00	3.00	3.00	3.00	3.00
Progresiva Projektit	Kanal	0.50	0.50	0.00	0.50	0.50	0.50
	Bankin						
	RRUGA						

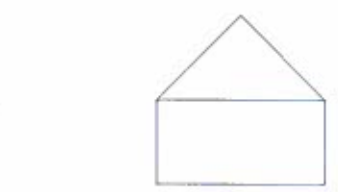

Gjermti i trupit te rruges kasonete	1.179m ²
Mbushje me Calulizhveon	0.088 m ²

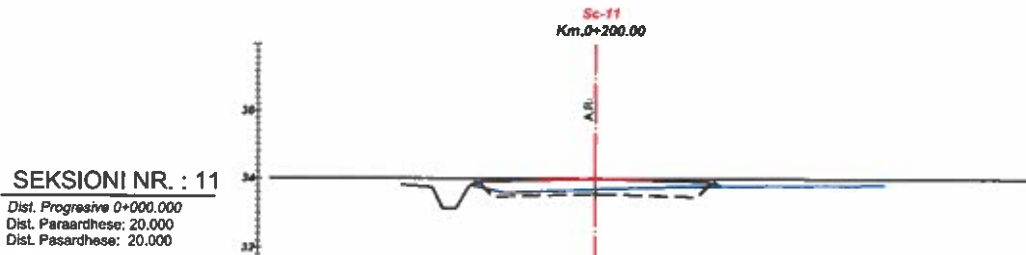

Kouta ref.30.00

Kuota Terrenit		33.80	33.82	33.70	33.70	33.60	33.54
Progresiva Terrenit		-3.46	-2.44	0.00	2.18	2.87	8.45
Kuota Projektit		3.00	3.00	3.00	3.00	3.00	3.00
Progresiva Projektit	Kanal	0.50	0.50	0.00	0.50	0.50	0.50
	Bankin						
	RRUGA						

Gjermti i trupit te rruges kasonete	1.094 m ²
Mbushje me Calulizhveon	0.047 m ²

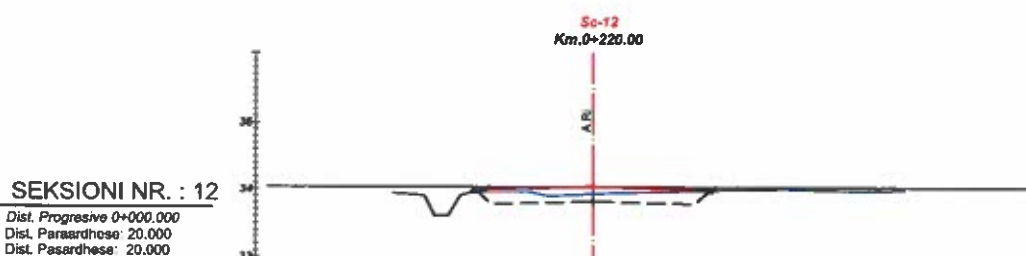

Kouta ref.30.00

Kuota Terrenit		33.86	33.78	33.78	33.86	34.02	33.97
Progresiva Terrenit		-4.51	-2.44	-1.77	0.00	2.55	4.62
Kuota Projektit		3.00	3.00	3.00	3.00	3.00	3.00
Progresiva Projektit	Kanal	0.50	0.50	0.00	0.50	0.50	0.50
	Bankin						
	RRUGA						

Gjermti i trupit te rruges kasonete	1.859m ²
Mbushje me Calulizhveon	0.001 m ²

RIKONSTRUKSIONI RRUGES NGA QENDRA DARZEZE - BREGDETE (ANA LINDORE)		FLETA 34
Proj. Konstruktor	Ing. Haxhi Avdullai	
Proj. ARKITEKTUNIK	Ark. Erald TAVANXHIU	
TOPOGRAF	Gj. Isidor PRIFTI	
Porosit	Bashkia FIER(QARKU FIER)	
		SHKURT 2025 BASHKIA FIER

**PROFILAT TERTHOR I SEGMENTIT TE RRUGES
QENDER DARZEZE - BREGDETE (ANA LINDORE) SH.1:100**

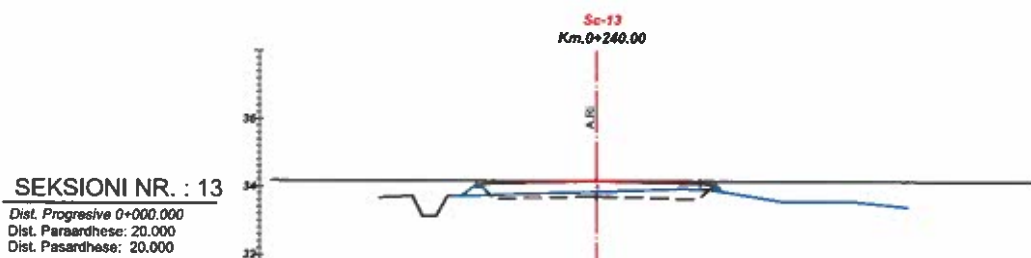

Kouta ref.30.00

Kuota Terrenit		33.71	33.76	33.78	33.82	33.86	33.95	33.94	33.83
Progresiva Terrenit		-4.35	-3.07	-2.41	-1.19	0.00	2.50	3.30	3.93
Kuota Projektit						34.17			
Progresiva Projektit	Kanal	0.50	Bankin	3.00	RRUGA	0.00	RRUGA	0.50	Bankin



Gjermi i trupit te rruges kasonale	1.087 m ²
Mbushje me Çetull(zhevor)	0.173 m ²

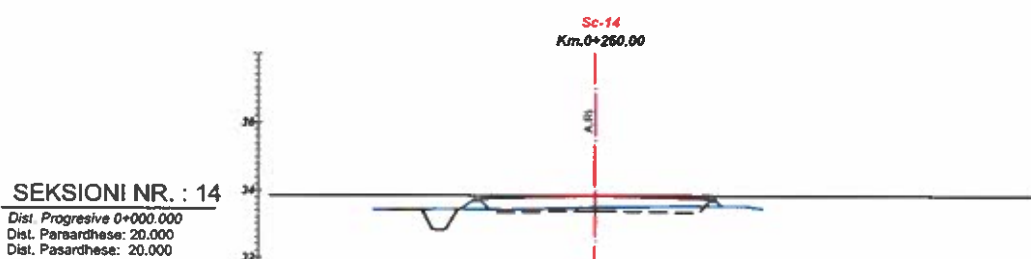

Kouta ref.30.00

Kuota Terrenit		33.41	33.47	33.44	33.52	33.56	33.57	33.46
Progresiva Terrenit		-4.46	-4.16	-2.57	0.00	2.50	4.11	4.07
Kuota Projektit					33.97			
Progresiva Projektit	Kanal	0.50	Bankin	3.00	RRUGA	0.00	RRUGA	0.50

Gjermi i trupit te rruges kasonale	0.738m ²
Mbushje me Çetull(zhevor)	0.191 m ²

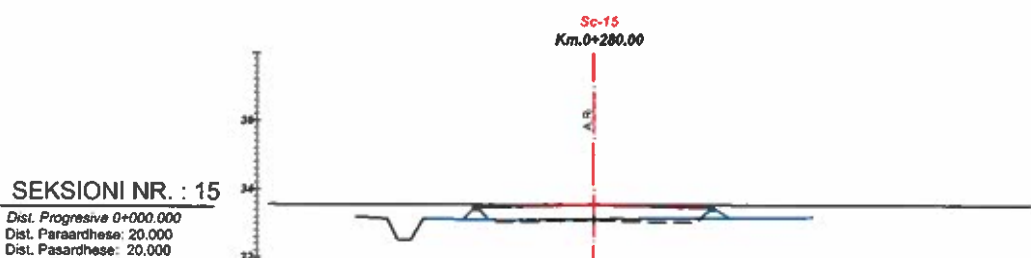

Kouta ref.30.00

Kuota Terrenit		33.18	33.11	33.15	33.37	33.27	33.19	33.22
Progresiva Terrenit		-3.55	-2.53	0.00	1.78	2.45	5.82	6.38
Kuota Projektit				33.57				
Progresiva Projektit	Kanal	0.50	Bankin	3.00	RRUGA	0.00	RRUGA	0.50

Gjermi i trupit te rruges kasonale	0.385 m ²
Mbushje me Çetull(zhevor)	0.258 m ²

RIKONSTRUKSIONI RRUGES NGA QENDRA DARZEZE - BREGDETE (ANA LINDORE)		35
DEPARTAMENTI I INZHINIERISIAVE DHE PROJEKTOVIMIT	Ing. Haxhi Avdullai	PRILET TERTHORE (PK.13-15)
PROJ. KONSTRUKTOR	Ing. Haxhi Avdullai	
PROJ. ARKITEKTONIK	Ark. Erald TAVANXHIU	SHKURT 2025
TOPOGRAF	GJ. Ilisidor PRIFTI	
POROSIT	Bashkia FIER(QARKU FIER)	BASHKIA FIER

PROFILAT TERTHOR I SEGMENTIT TE RRUGES QENDER DARZEZE - BREGDETE (ANA LINDORE) SH.1:100

SEKSIONI NR. : 16

Dist. Progressive 0+300.000
Dist. Paraardhese: 20.000
Dist. Pasardhese: 20.000

Kouta ref.30.00

Kuota Terrenit		32.98	32.94	32.93	32.95	32.96	32.89	32.88	
Progresiva Terrenit		-4.54	-3.61	-2.57	-0.97	0.00	2.46	3.77	
Kuota Projektit			Bankin			33.27		Bankin	
Progresiva Projektit	Kanal	0.50	0.50	3.00	0.00	3.00	0.50	0.50	RRUGA



Gjerme i trupit te rruges kasetore	1.068 m ²
Mbushje me Çakull(zheron)	0.126 m ²

SEKSIONI NR. : 17

Dist. Progressive 0+320.000
Dist. Paraardhese: 20.000
Dist. Pasardhese: 20.000

Kouta ref.30.00

Kuota Terrenit		32.80	32.78	32.84	32.86	32.88	32.94	33.05	
Progresiva Terrenit		-4.65	-3.72	-3.03	0.00	3.01	4.88	5.73	
Kuota Projektit			Bankin		33.94		Bankin		
Progresiva Projektit	Kanal	0.50	0.50	3.00	0.00	3.00	0.50	0.50	RRUGA

Gjerme i trupit te rruges kasetore	0.000 m ²
Mbushje me Çakull(zheron)	5.900 m ²

SEKSIONI NR. : 19

Dist. Progressive 0+340.000
Dist. Paraardhese: 20.000
Dist. Pasardhese: 20.000

Kouta ref.30.00

Kuota Terrenit		32.64	32.90	32.91	32.91	32.94			
Progresiva Terrenit		-4.98	-2.13	0.00	2.49	8.88			
Kuota Projektit			Bankin			Bankin			
Progresiva Projektit	Kanal	0.50	0.50	3.00	0.00	3.00	0.50	0.50	RRUGA

Gjerme i trupit te rruges kasetore	0.000 m ²
Mbushje me Çakull(zheron)	5.872 m ²

RIKONSTRUKSIONI RRUGES NGA QENDRA DARZEZE - BREGDETE (ANA LINDORE)		BLIETA K-36
Ing. Haxhi Avdullai	Ing. Haxhi Avdullai	PROFILAT TERTHORE (17-18-19)
PROJ. KONSTRUKTOR	Ark. Erald TAVANXHIU	
TOPUGRAF	G.J. Ilisidor PRIFTI	SEKURIT 2025
POROSITI	Bashkia FIER(QARKU FIER)	BASHKIA FIER

PROFILAT TERTHOR I SEGMENTIT TE RRUGES QENDER DARZEZE - BREGDETE (ANA LINDORE) SH.1:100

SEKSIONI NR. : 01

Dist. Progressive 0+380.000
Dist. Paraardhese: 20.000
Dist. Pasardhese: 20.000



Kouta ref.30.00

Kuota Terrenit		32.68	32.80	32.95	32.97	32.91	32.99	33.00	32.89
Progressiva Terrenit		-5.74	-4.42	-1.88	0.00	2.06	2.88	3.40	3.96
Kuota Projektit					34.02				
Progressiva Projektit	Kanal	0.50	Bankin	3.00	RRUGA	3.00	RRUGA	0.50	Bankin

Gjermi i lupti te shqyrtuar kostonet	0.000 m ²
Mbushja me Çetull(zhavorr)	5.208 m ²

SEKSIONI NR. : 02

Dist. Progressive 0+380.000
Dist. Paraardhese: 20.000
Dist. Pasardhese: 20.000

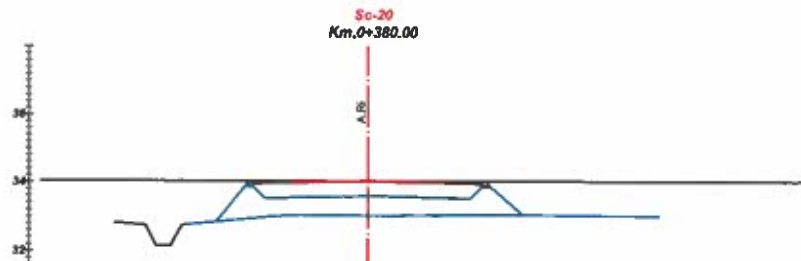

Kouta ref.30.00

Kuota Terrenit		33.03	33.28	33.31	33.30	33.30	33.31	33.33	33.30
Progressiva Terrenit		-6.36	-2.77	-2.03	0.00	0.77	2.03	3.71	4.20
Kuota Projektit					34.02				
Progressiva Projektit	Kanal	0.50	Bankin	3.00	RRUGA	3.00	RRUGA	0.50	Bankin

Gjermi i lupti te shqyrtuar kostonet	0.000 m ²
Mbushja me Çetull(zhavorr)	4.789 m ²

SEKSIONI NR. : 02

Dist. Progressive 0+400.000
Dist. Paraardhese: 20.000
Dist. Pasardhese: 20.000

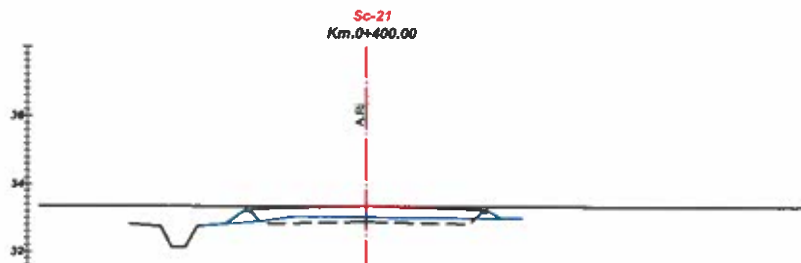

Kouta ref.30.00

Kuota Terrenit		32.75	32.94	33.06	33.05	33.04	33.01	33.02	33.02
Progressiva Terrenit		-4.90	-2.88	-2.11	0.00	2.11	2.88	4.23	4.23
Kuota Projektit					33.38				
Progressiva Projektit	Kanal	0.50	Bankin	3.00	RRUGA	3.00	RRUGA	0.50	Bankin

Gjermi i lupti te shqyrtuar kostonet	0.995 m ²
Mbushja me Çetull(zhavorr)	0.283 m ²

RIKONSTRUKSIONI RRUGES NGA QENDRA DARZEZE - BREGDETE (ANA LINDORE)		RUPA K-37
PRUJ Konstruktore	Ing. Haxhi Avdullai	
PRUJ ARKITEKTONIK	Ark. Enald TAVANXHIU	
TOPOGRAF	Gj. Isidor PRIFTI	PRUJ TERTHORE (19-21)
POKOSIT	Bashkia FIER(QARKU FIER)	SHKURT 2025 BASHKIA FIER

PROFILAT TERTHOR I SEGMENTIT TE RRUGES QENDER DARZEZE - BREGDETE (ANA LINDORE) SH.1:100

SEKSIONI NR. : 22

Dist. Progressive 0+420.000
Dist. Paraardhese: 00.000
Dist. Pasardhese: 20.000

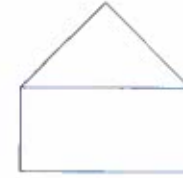

Kouta ref.30.00

Kuota Terrenit		32.80	32.84	33.43	33.43	33.12	33.05	33.05
Progresiva Terrenit		-4.88	-4.44	-2.39	-1.84	2.39	4.06	4.41
Kuota Projektit								
Progresiva Projektit	Kanal	0.50	Bankin	3.00	RRUGA	0.00	RRUGA	0.50

Gjerme i llogarit te shages kasonete	0.896 m ²
Mbushje me Caku(zhvorr)	0.270 m ²

SEKSIONI NR. : 23

Dist. Progressive 0+440.000
Dist. Paraardhese: 20.000
Dist. Pasardhese: 20.000

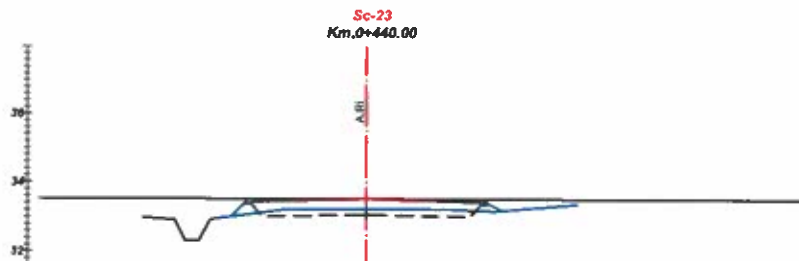

Kouta ref.30.00

Kuota Terrenit		33.02	32.86	33.22	33.24	33.23	33.23	33.17	33.36
Progresiva Terrenit		-4.57	-4.11	-2.40	-1.11	2.39	3.74	6.12	
Kuota Projektit									
Progresiva Projektit	Kanal	0.50	Bankin	3.00	RRUGA	0.00	RRUGA	0.50	

Gjerme i llogarit te shages kasonete	1.056 m ²
Mbushje me Caku(zhvorr)	0.262 m ²

SEKSIONI NR. : 24

Dist. Progressive 0+460.000
Dist. Paraardhese: 20.000
Dist. Pasardhese: 20.000



Kouta ref.30.00

Kuota Terrenit		33.32	33.07	33.20	33.31	33.34	33.35	33.36	33.32	34.12
Progresiva Terrenit		-4.03	-3.04	-2.30	0.00	0.79	2.30	2.88	8.42	
Kuota Projektit										
Progresiva Projektit	Kanal	0.50	Bankin	3.00	RRUGA	0.00	RRUGA	0.50	Bankin	

Gjerme i llogarit te shages kasonete	1.105 m ²
Mbushje me Caku(zhvorr)	0.237 m ²

RIFRONSIONI RRUGES NGA QENDRA DARZEZE - BREGDETE (ANA LINDORE)		K-38
PRONJ. KONSTRUKTOR	Ing. Haxhi Avdullai	
PRONJ. ARKITEKTONIK	Ing. Haxhi Avdullai	
TOPOGRAF	Ark. Era TAVANXHIU	
POKOSITI	GJ. Isidor PRIFTI	
Bashkia FIER(QARKU FIER)		SHKURT 2025 BASHKIA FIER

PROFILAT TERTHOR I SEGMENTIT TE RRUGES QENDER DARZEZE - BREGDETE (ANA LINDORE) SH.1:100

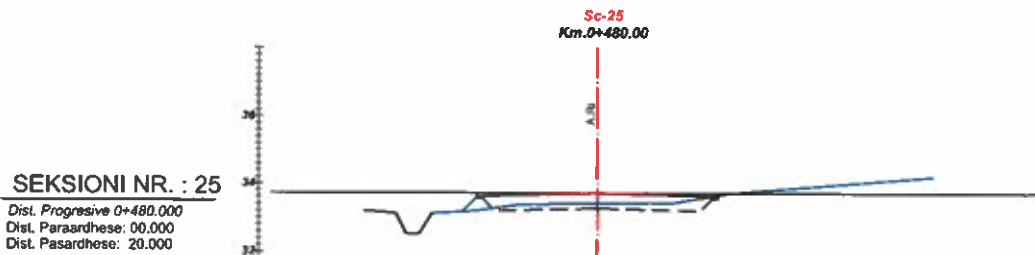

SEKSIONI NR. : 25
Dist. Progressive 0+480.000
Dist. Paraardhese: 00.000
Dist. Pasardhese: 20.000

Kouta ref.30.00

Kuota Terrenit		33.19	33.38	33.41	33.44	33.81	34.53
Progresiva Terrenit		-3.58	-2.24	0.00	1.94	3.86	9.74
Kuota Projektit		33.17	33.37	33.72	33.72	33.81	34.53
Progresiva Projektit	Kanal	0.50	Bankin	RRUGA	RRUGA	0.50	Bankin

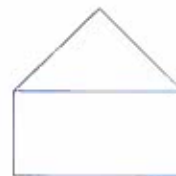

Gjerimi i trupit te rruges kazonete	1.136m ²
Mbueshte me Caku(zhavori)	0.185 m ²

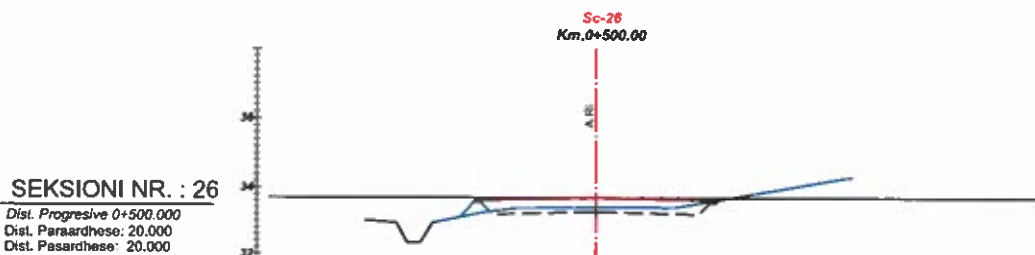

SEKSIONI NR. : 26
Dist. Progressive 0+500.000
Dist. Paraardhese: 20.000
Dist. Pasardhese: 20.000

Kouta ref.30.00

Kuota Terrenit		33.19	33.26	33.38	33.41	33.42	34.31
Progresiva Terrenit		-3.90	-3.24	-2.29	0.00	0.69	2.28
Kuota Projektit		33.17	33.37	33.72	33.72	33.81	34.31
Progresiva Projektit	Kanal	0.50	Bankin	RRUGA	RRUGA	0.50	Bankin

Gjerimi i trupit te rruges kazonete	1.091m ²
Mbueshte me Caku(zhavori)	0.183 m ²

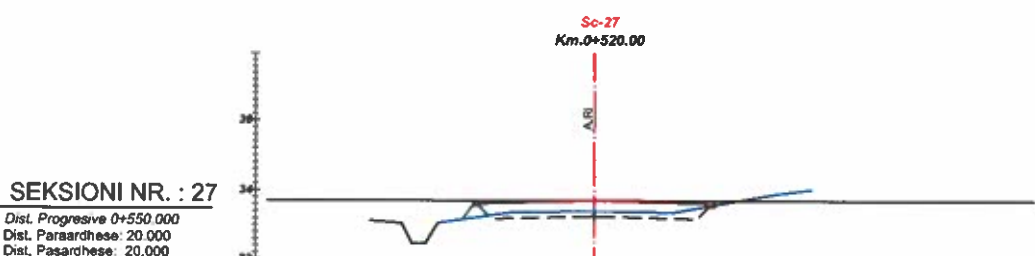

SEKSIONI NR. : 27
Dist. Progressive 0+550.000
Dist. Paraardhese: 20.000
Dist. Pasardhese: 20.000

Kouta ref.30.00

Kuota Terrenit		33.17	33.30	33.37	33.70	33.37	33.90
Progresiva Terrenit		-4.09	-2.90	-2.33	-0.55	0.00	2.34
Kuota Projektit		33.17	33.37	33.72	33.72	33.81	34.04
Progresiva Projektit	Kanal	0.50	Bankin	RRUGA	RRUGA	0.50	Bankin

Gjerimi i trupit te rruges kazonete	0.967 m ²
Mbueshte me Caku(zhavori)	0.160 m ²

RIKONSTRUKSIONI RRUGES NGA QENDRA DARZEZE - BREGDETE (ANA LINDORE)		FLETA K-39
PRUJ Konstruktior	Ing. Haxhi Avdullai	
PRUJ ARKITEKTONIK	Ark. Erald TAVANXHIU	
TOPOGRAF	G.J. Ihsidor PRIFTI	
POZICION	Bashkia FIER/QARKU FIER	
		PROFILAT TERTHORE (PK.25-27) SHKURT 2025 BASHKIA FIER

**PROFILAT TERTHOR I SEGMENTIT TE RRUGES
QENDER DARZEZE - BREGDETE (ANA LINDORE) SH.1:100**

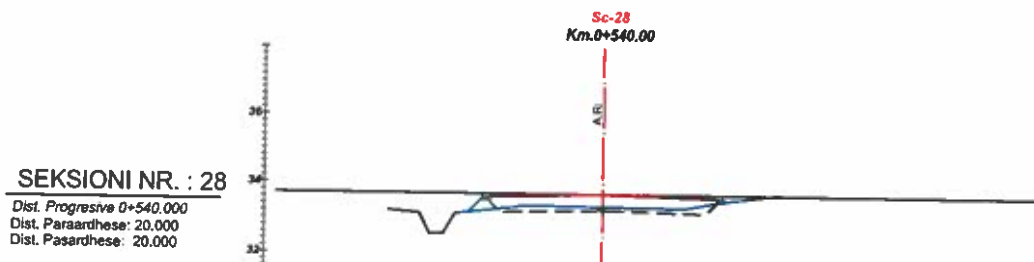

SEKSIONI NR. : 28
Dist. Progressive 0+540.000
Dist. Paraardhese: 20.000
Dist. Pasardhese: 20.000

Kuota ref.30.00

Kuota Terrenit		33.15	33.35	33.35	33.33	33.51	34.06
Progresiva Terrenit		-4.29	-2.37	0.00	2.38	1.42	5.18
Kuota Projektit							
Progresiva Projektit	Kanal	0.50	3.00	0.00	3.00	0.50	
		Bankin	RRUGA		RRUGA	Bankin	

Qermeti i trupit te rruges kasonete	0.821 m ²
Mbashtja me Çetull(zhvoren)	0.167m ²

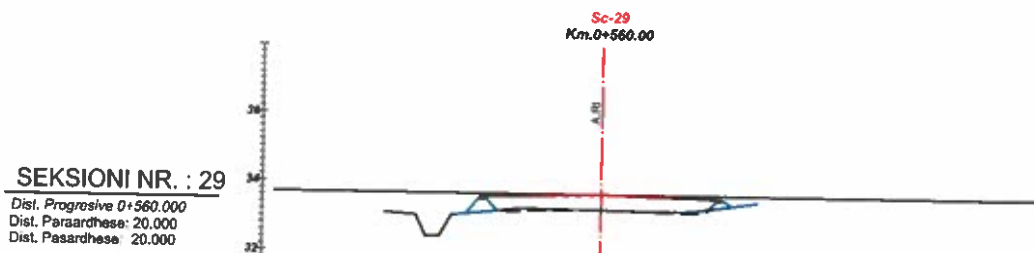

SEKSIONI NR. : 29
Dist. Progressive 0+560.000
Dist. Paraardhese: 20.000
Dist. Pasardhese: 20.000

Kuota ref.30.00

Kuota Terrenit		33.06	33.27	33.25	33.23	33.23	33.51
Progresiva Terrenit		-4.34	-2.39	0.00	1.85	2.38	4.55
Kuota Projektit							
Progresiva Projektit	Kanal	0.50	3.00	0.00	3.00	0.50	
		Bankin	RRUGA		RRUGA	Bankin	

Qermeti i trupit te rruges kasonete	0.188 m ²
Mbashtja me Çetull(zhvoren)	0.305 m ²



SEKSIONI NR. : 30
Dist. Progressive 0+580.000
Dist. Paraardhese: 20.000
Dist. Pasardhese: 20.000

Kuota ref.30.00

Kuota Terrenit		33.11	33.24	33.20	33.41	33.41	33.54
Progresiva Terrenit		-4.20	-2.99	0.00	2.34	3.19	4.50
Kuota Projektit							
Progresiva Projektit	Kanal	0.50	3.00	0.00	3.00	0.50	
		Bankin	RRUGA		RRUGA	Bankin	

Qermeti i trupit te rruges kasonete	3.041 m ²
Mbashtja me Çetull(zhvoren)	0.001 m ²

RIKONSTRUKSIONI RRUGES NGA QENDRA DARZEZE - BREGDETE (ANA LINDORE)		PLAN K-40
Proj. Konstruktor	Ing. Haxhi Avdullahi	
Proj. Arkitektonik	Ark. Enal TAVANXHIU	
TOPOGRAF	Gj. Ilisidor PRIFTI	
POSOSITI	Bashkia FIER(QARKU FIER)	
		SHKURT 2025 BASHKIA FIER

**PROFILAT TERTHOR I SEGMENTIT TE RRUGES
QENDER DARZEZE - BREGDETE (ANA LINDORE) SH.1:100**

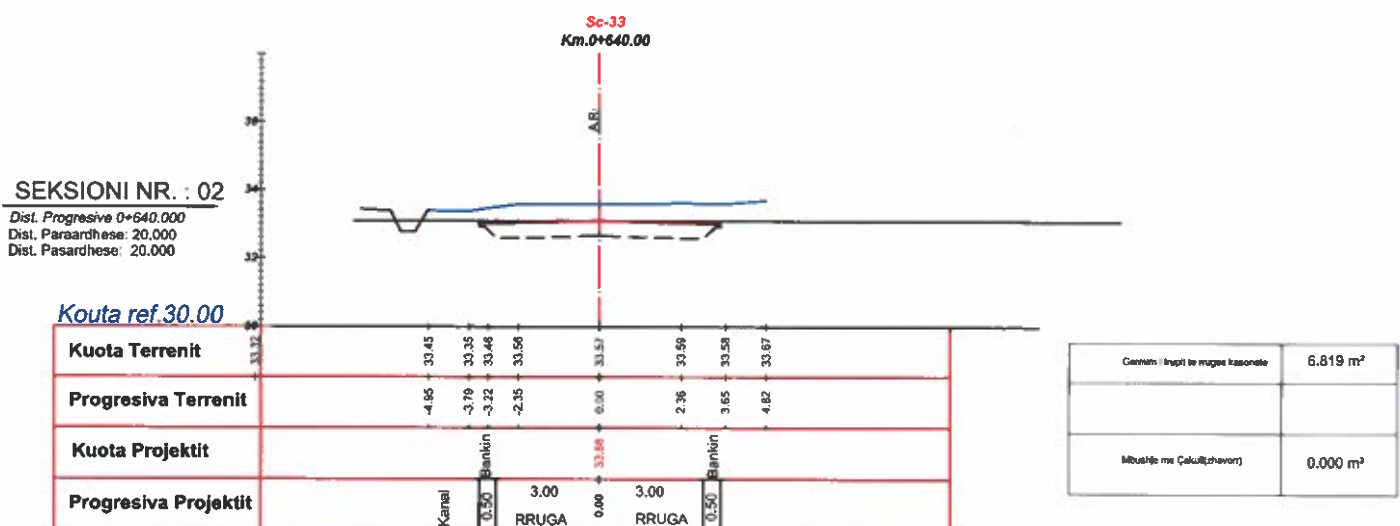
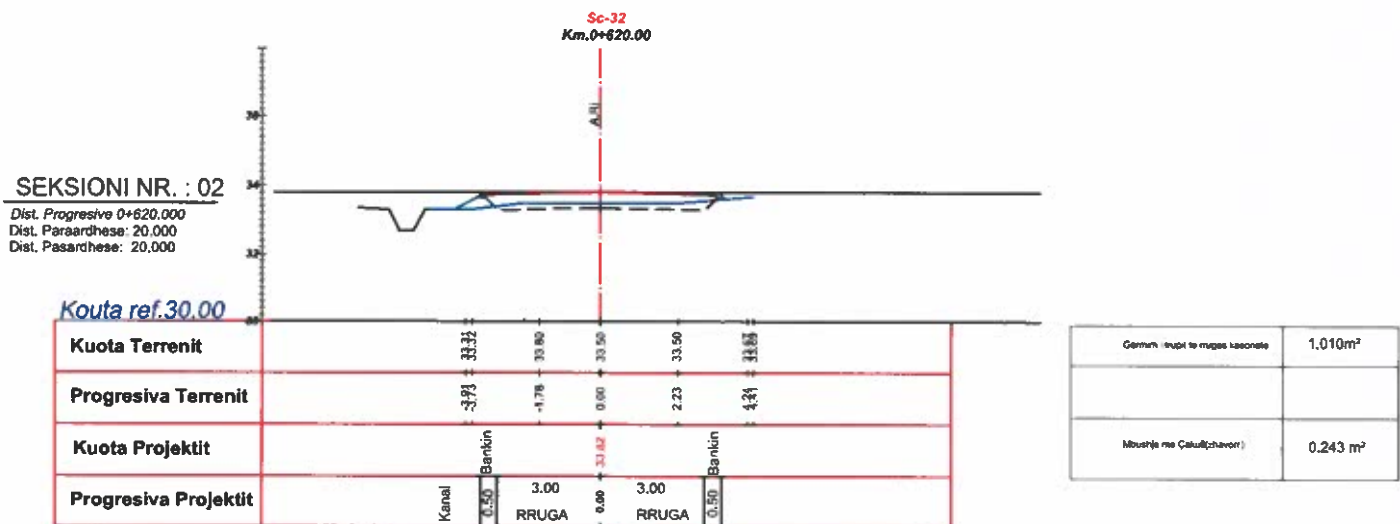
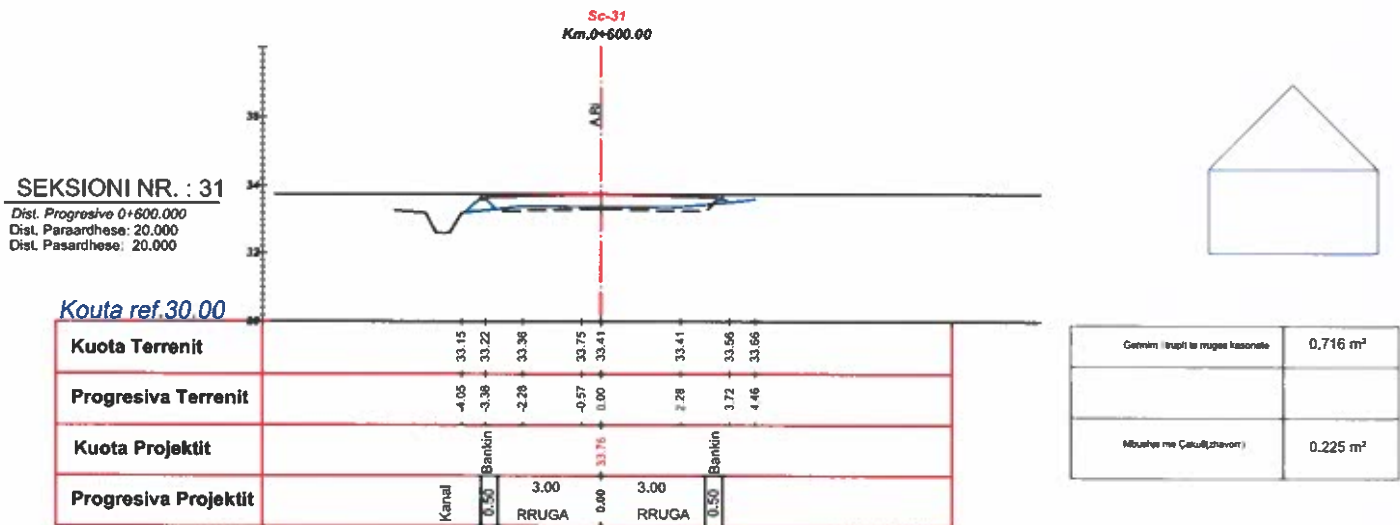

RIKONSTRUKSIONI RRUGES NGA QENDRA DARZEZE - BREGDETE (ANA LINDORE)		RRETA K-41	
PRUJ Konstruktore	Ing. Haxhi Avdullai	PRUJ Arkitekturore	Ark. Emir TAVANXHIU
TOPOGRAF	GJ. Isidor PRIFTI	SHKURT 2025	
POKES	Bashkia FIER(QARKU FIER)	BASHKIA FIER	

PROFILAT TERTHORI I SEGMENTIT TE RRUGES QENDER DARZEZE - BREGDETE (ANA LINDORE) SH.1:100

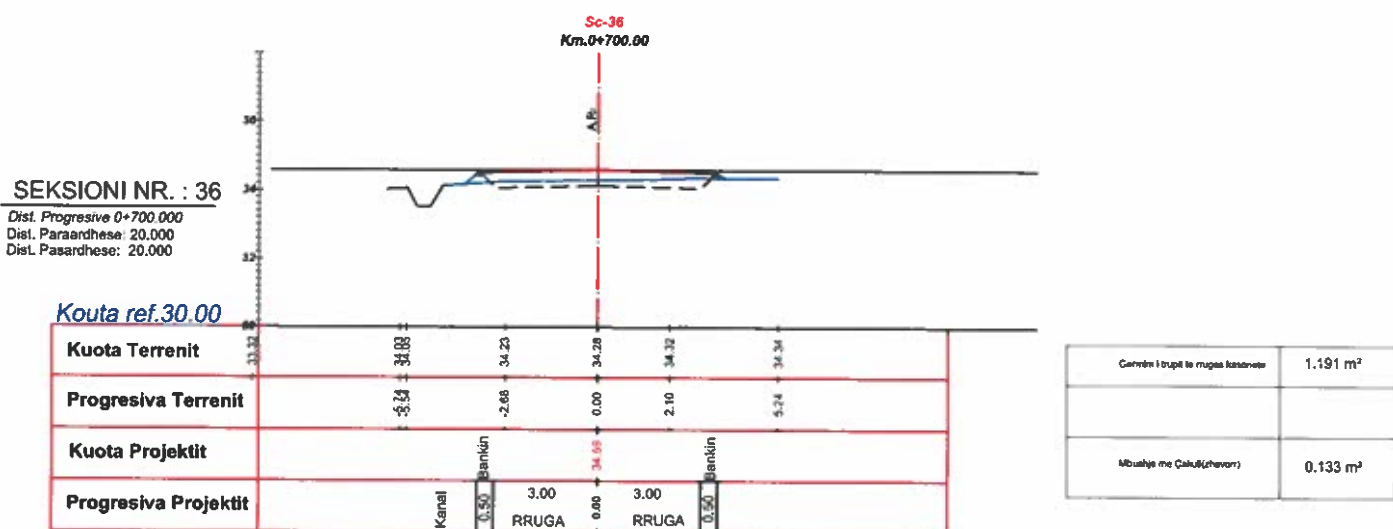
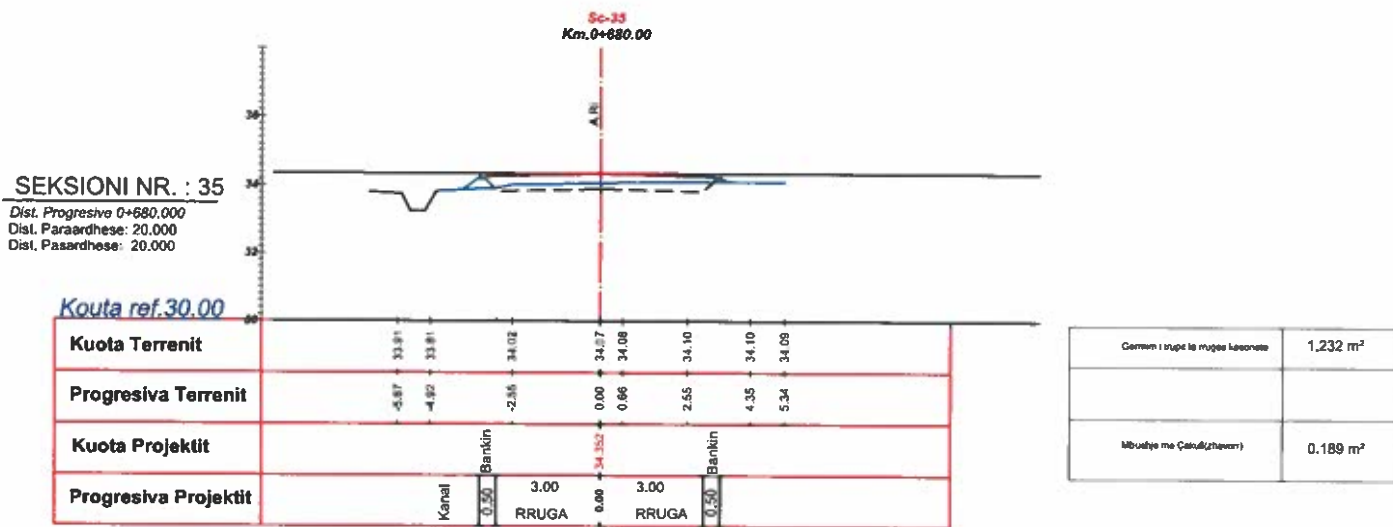
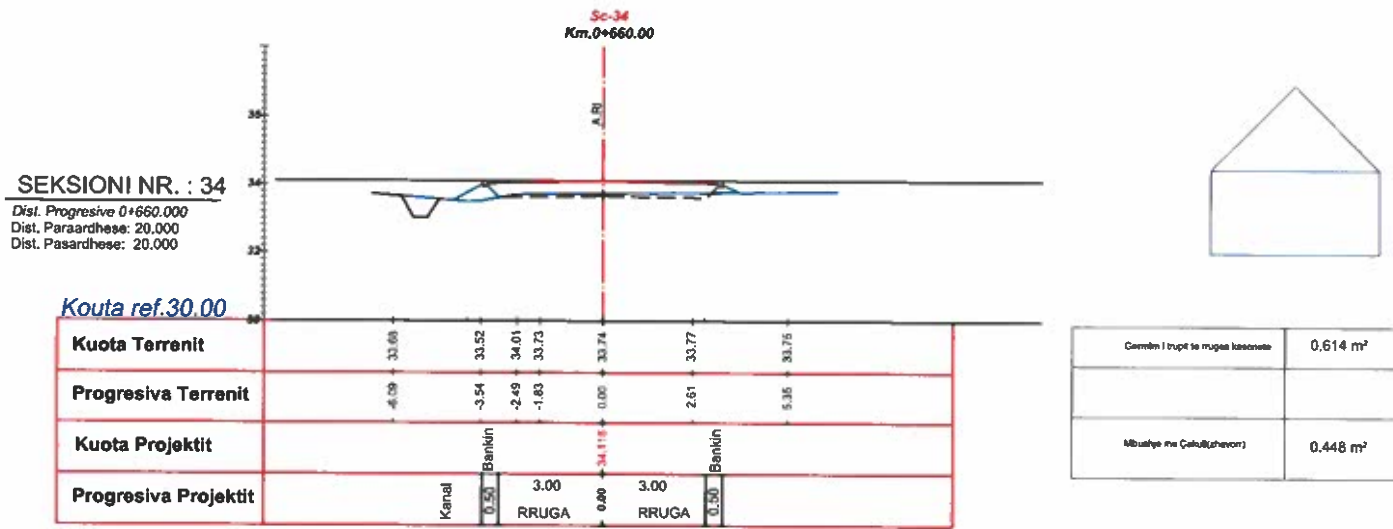

RIKONSTRUKSIONI RRUGES NGA QENDRA DARZEZE - BREGDETE (ANA LINDORE)		PLETA 42
PRU Konstruktor	Ing. Haxhi Avdullai	
PRU Arkitekturik	Ark. Erald TAVANXHIU	
TOPOGRAF	GJ. Iksidor PRIFTI	
POROSIT	Bashkia FIER/QARKU FIER	
		PROJEKT TERTHORE (PK.34-36) SHKURT 2025 BASHKIA FIER

PROFILAT TERTHOR I SEGMENTIT TE RRUGES QENDER DARZEZE - BREGDETE (ANA LINDORE) SH.1:100

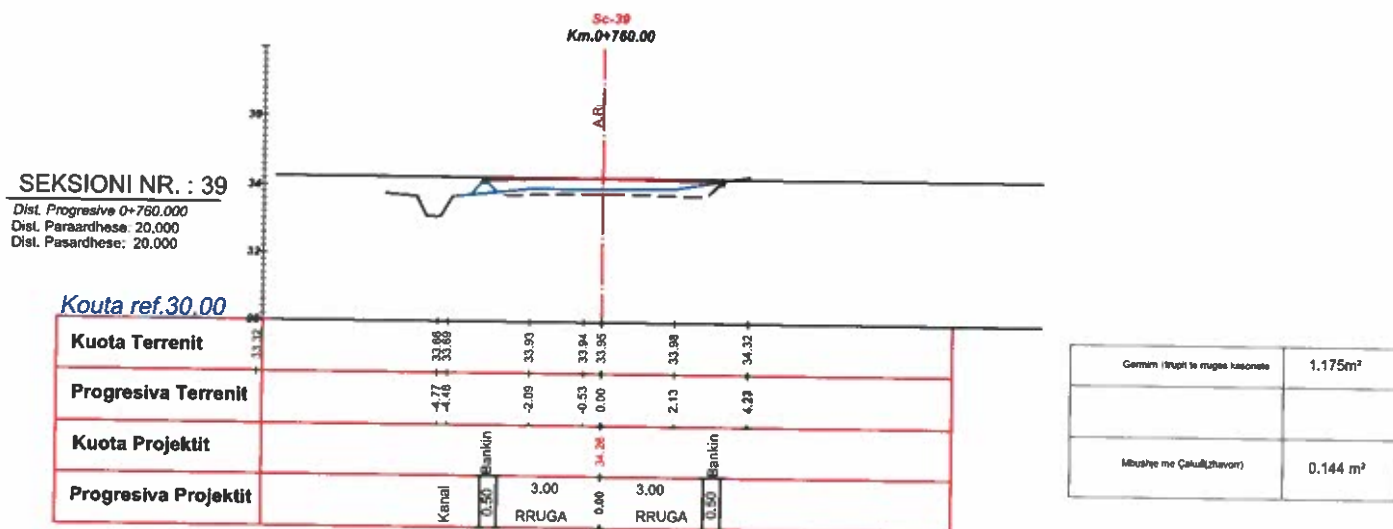
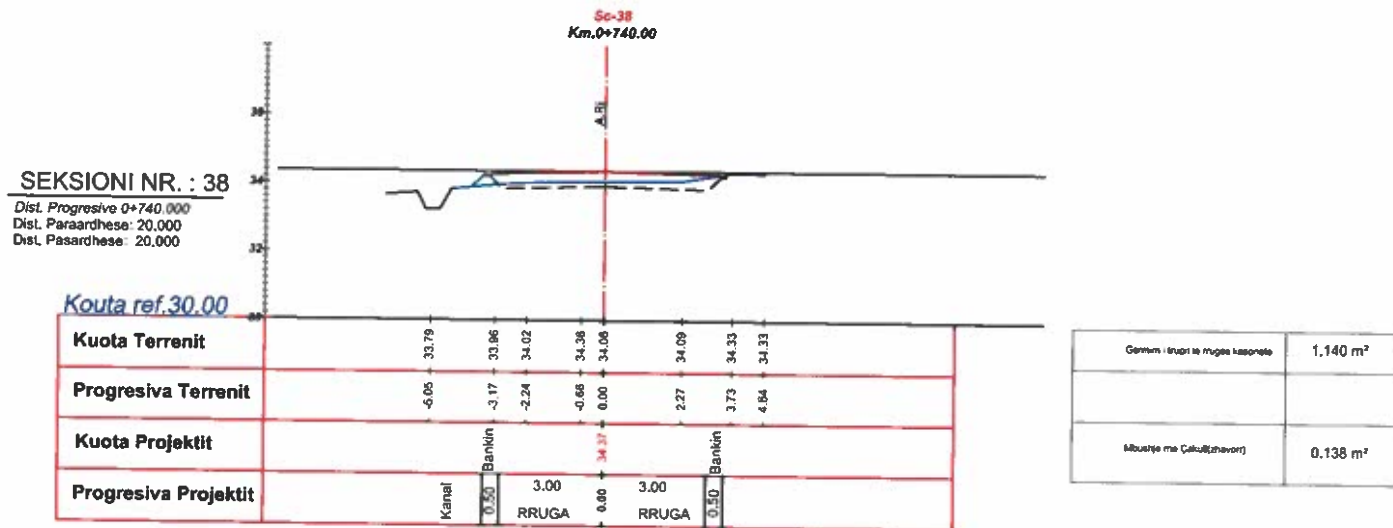
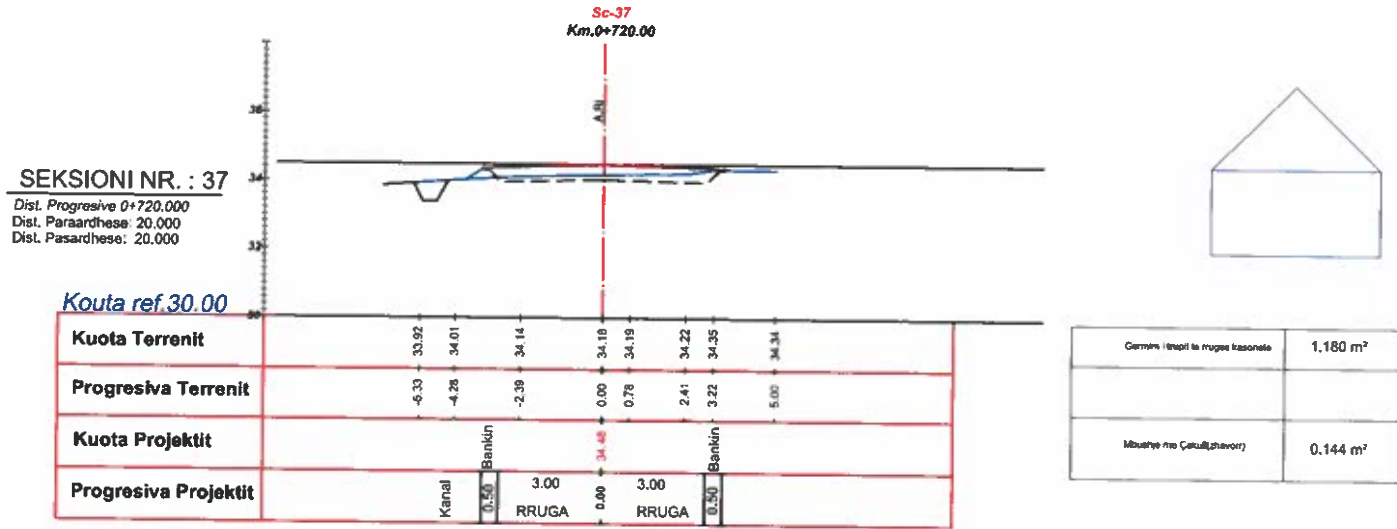

RIKONSTRUKSIONI RRUGES NGA QENDRA DARZEZE - BREGDETE (ANA LINDORE)		FLETA K-43
PROJEKTUESI Ing. Haxhi Avdullai	PROJEKTUESI Ing. Haxhi Avdullai	PROFILI TERTHORE (PK.37-39)
PROJ. ARKITEKTONIK Ark. Enaid TAVANXHIU	PROJ. TOPOGRAF Gj. Isidor PRIFTI	SHKURT 2025
Bashkia FIER(QARKU FIER)		BASHKIA FIER

**PROFILAT TERTHOR I SEGMENTIT TE RRUGES
QENDER DARZEZE - BREGDETE (ANA LINDORE) SH.1:100**

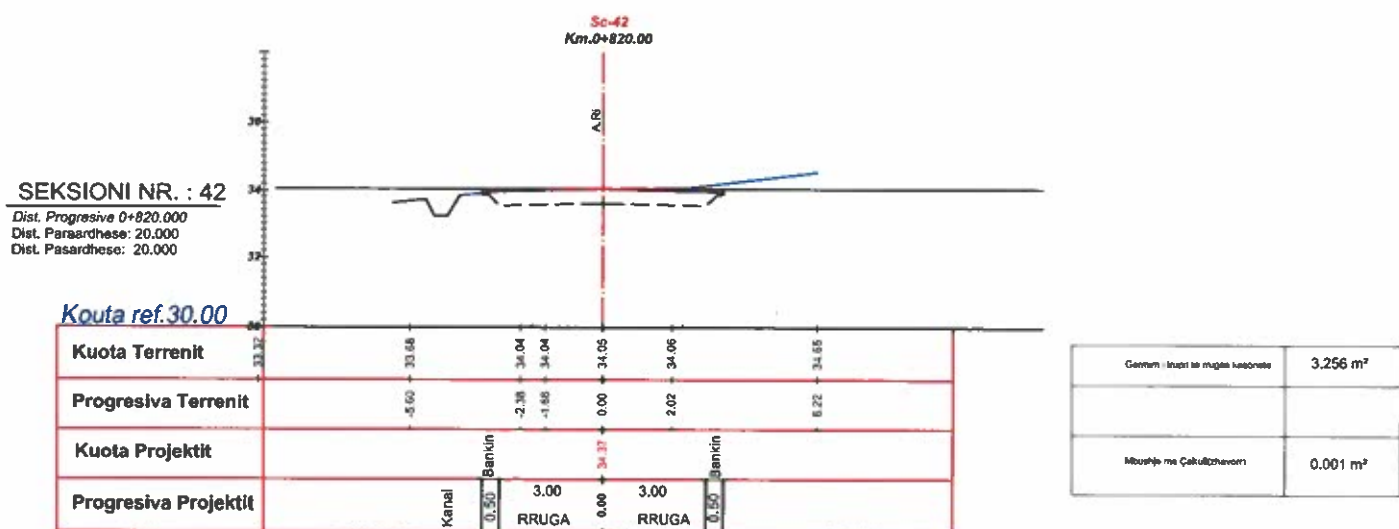
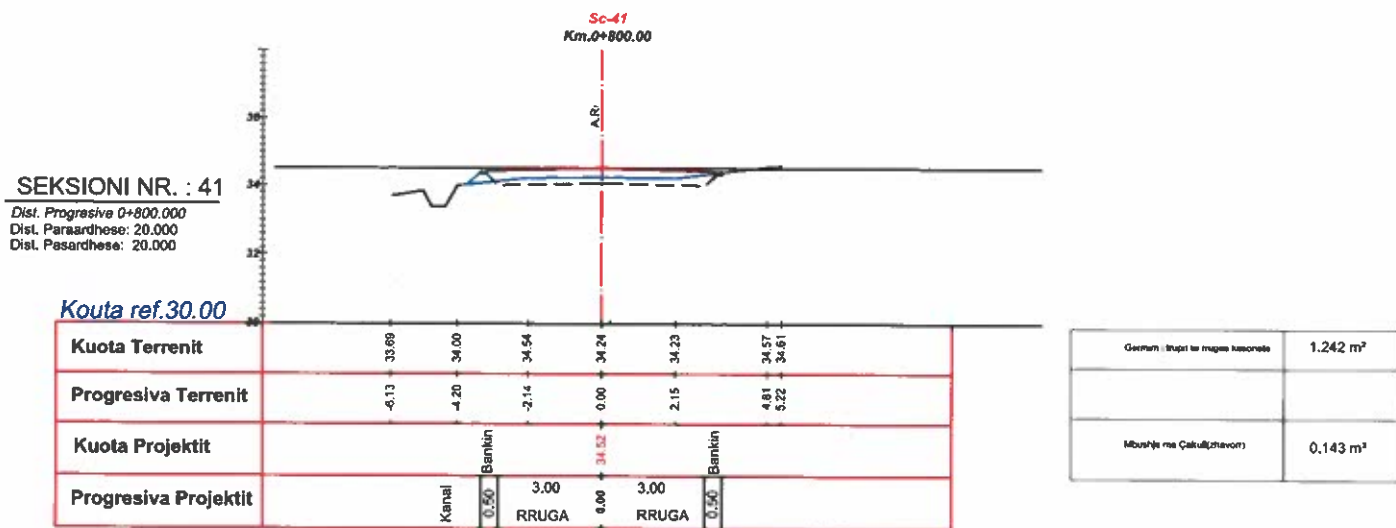
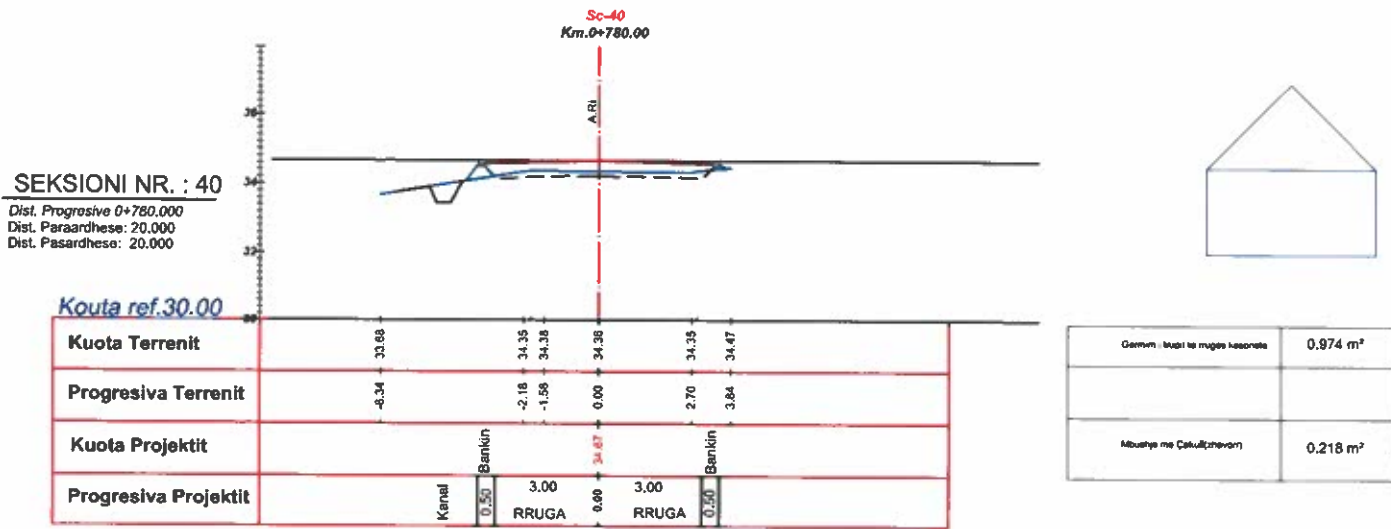

RIKONSTRUKSIONI RRUGES NGA QENDRA DARZEZE - BREGDETE (ANA LINDORE)			
DEPARTAMENTI I PUNIMEVE TE PUBLIKES	Ing.	Haxhi Avdullai	
PRU Konstruktor	Ing.	Haxhi Avdullai	
PRU Arkitekturik	Ark.	Eradi TAVANXHIU	
TOPOGRAF	GJ.	Ilsidor PRIFTI	
POKOSHI	Bashkia FIER(QARKU FIER)		BASHKIA FIER

**PROFILAT TERTHOR I SEGMENTIT TE RRUGES
QENDER DARZEZE - BREGDETE (ANA LINDORE) SH.1:100**

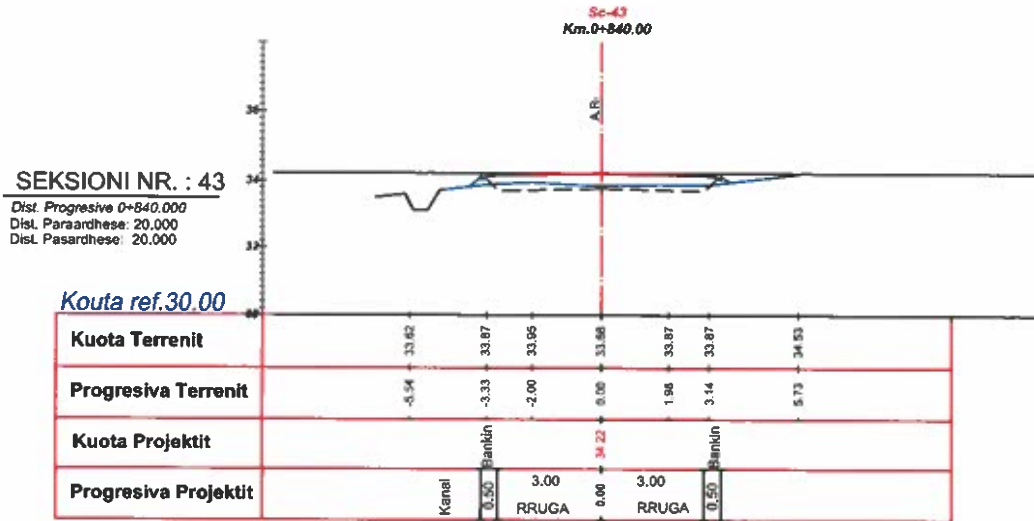

Gjermi i trupit te rruges kasonete	0.918 m ³
Mbushje me Çakull(zhavor)	0.154 m ³

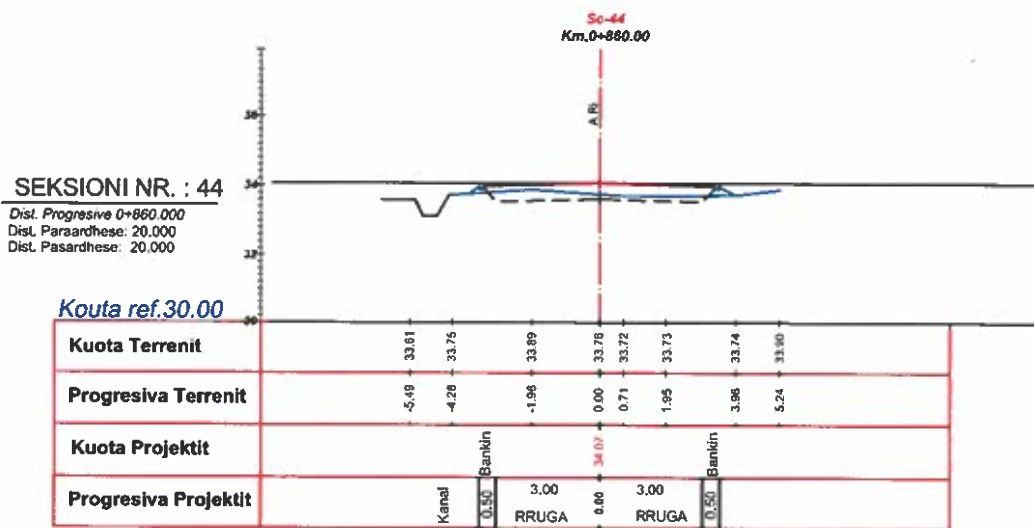

Gjermi i trupit te rruges kasonete	1.190 m ³
Mbushje me Çakull(zhavor)	0.143 m ³

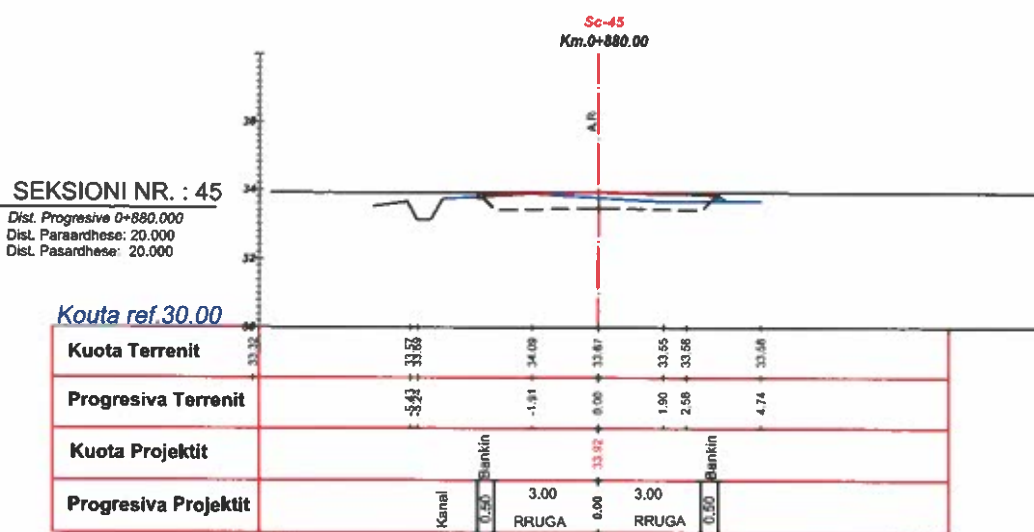

Gjermi i trupit te rruges kasonete	2.068m ³
Mbushje me Çakull(zhavor)	0.038 m ³

		RIKONSTRUKSIONI RRUGES NGA QENDRA DARZEZE - BREGDETE (ANA LINDORE)		FLETA K-45
		PRUJ Konstruktore PRUJ Arkitekturore TOPOGRAF PËRSHI	Ing. Haxhi Avdullai Ing. Haxhi Avdullai Ark. Erald TAVANXHIU GJ. Ilisidor PRIFTI Bashkia FIER(QARKU FIER)	

**PROFILAT TERTHOR I SEGMENTIT TE RRUGES
QENDER DARZEZE - BREGDETE (ANA LINDORE) SH.1:100**

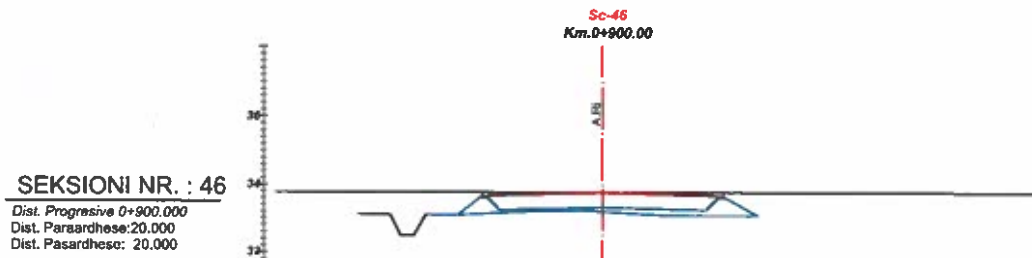

Kouta ref.30.00

Kuota Terrenit		33.49	33.24	33.57	33.20	33.05	33.00
Progresiva Terrenit		-4.86	-4.60	-1.94	0.00	1.91	3.49
Kuota Projektit					33.77		
Progresiva Projektit			0.50	3.00	0.00	3.00	0.50
			Kanal	Bankin	RRUGA	RRUGA	Bankin

Gjermi i trupit te rruges kasonete	0.000 m ²
Mbushje me Cakull(zhavor)	1.593 m ²

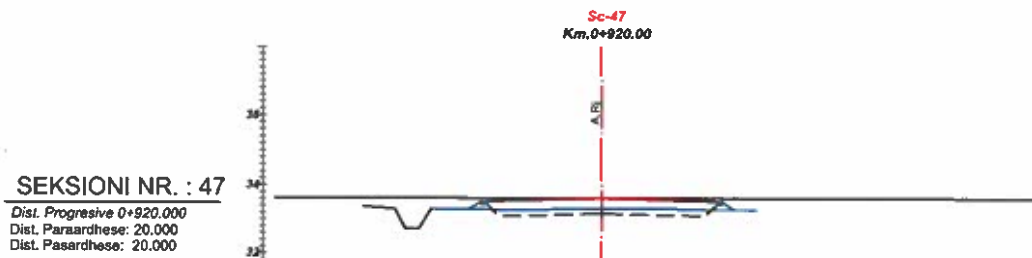

Kouta ref.30.00

Kuota Terrenit		33.29	33.30	33.31	33.32	33.29
Progresiva Terrenit		-7.99	-1.35	0.00	2.02	2.80
Kuota Projektit				33.62		
Progresiva Projektit			0.50	3.00	0.00	3.00
			Kanal	Bankin	RRUGA	RRUGA

Gjermi i trupit te rruges kasonete	1.007 m ²
Mbushje me Cakull(zhavor)	0.154 m ²

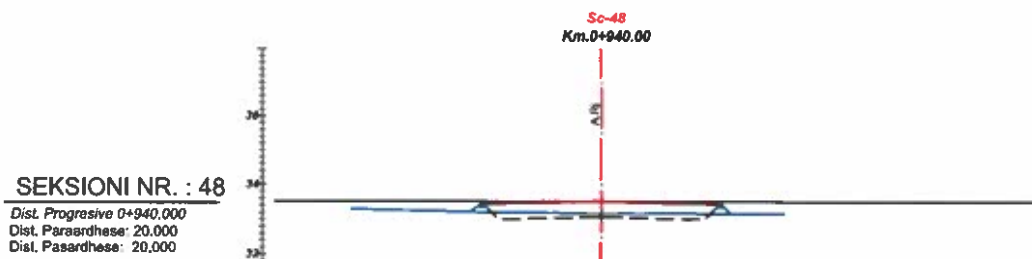

Kouta ref.30.00

Kuota Terrenit		33.60	33.22	33.21	33.18	33.19	33.17
Progresiva Terrenit		-7.23	-3.01	-1.78	0.00	1.93	3.21
Kuota Projektit					33.53		
Progresiva Projektit			0.50	3.00	0.00	3.00	0.50
			Kanal	Bankin	RRUGA	RRUGA	Bankin

Gjermi i trupit te rruges kasonete	0.880 m ²
Mbushje me Cakull(zhavor)	0.143 m ²

RIKONSTRUKSIONI RRUGES NGA QENDRA DARZEZE - BREGDETE (ANA LINDORE)		FLETA K-46
PRUJ. KONSTRUKTOR	Ing. Haxhi Avdullai	
PRUJ. ARKITEKTONIK	Ark. Enid TAVANXHIU	
TOPOGRAF	GJ. Ilisidor PRIFTI	
PRUJ. POKOSI	Bashkia FIER(QARKU FIER)	
		PROJEKT TERTHORE (PK-46-48) SHKURT 2025 BASHKIA FIER

**PROFILAT TERTHOR I SEGMENTIT TE RRUGES
QENDER DARZEZE - BREGDETE (ANA LINDORE) SH.1:100**

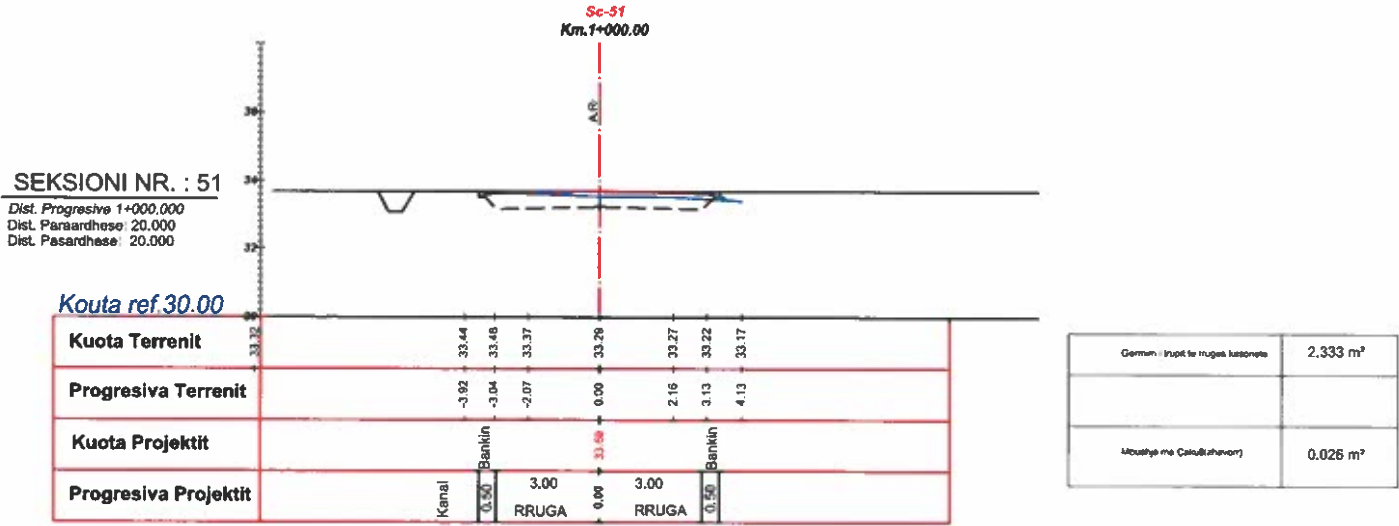
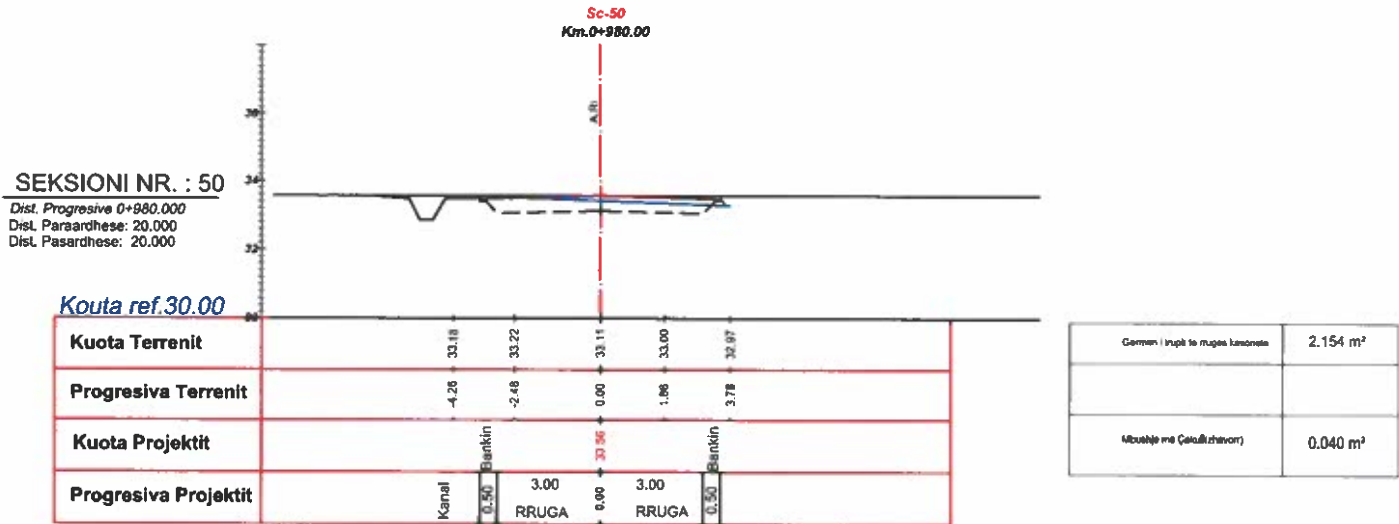
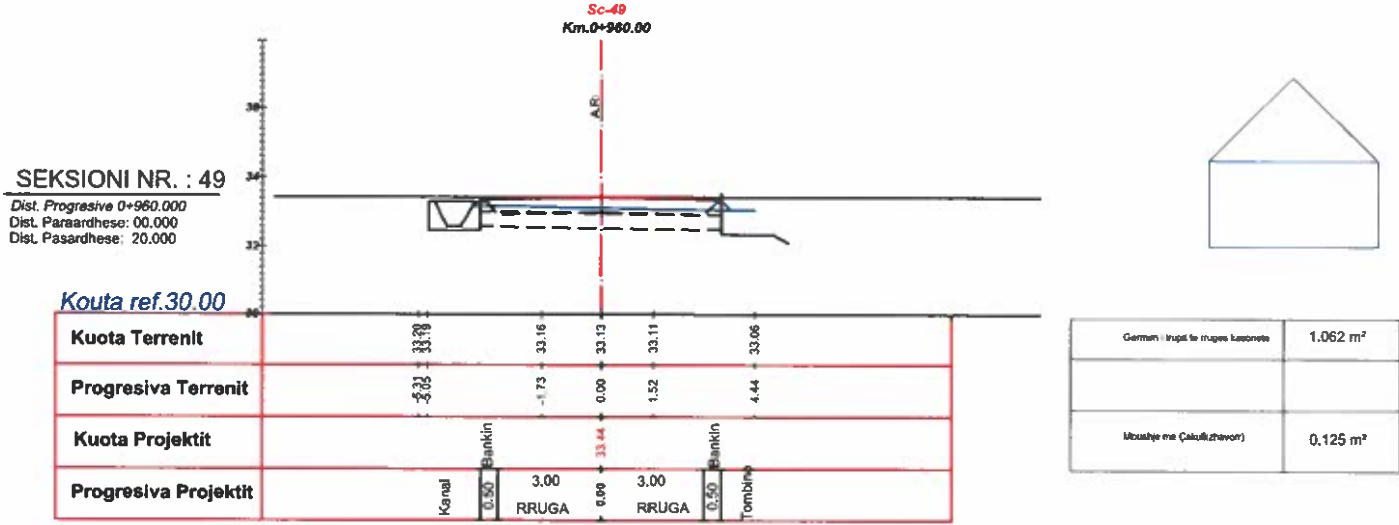

RIKONSTRUKSIONI RRUGES NGA QENDRA DARZEZE - BREGDETE (ANA LINDORE)				PLANI K-47
DEPARTAMENTI I PUNIMEVE DHE INZHENERIT	Ing.	Haxhi Avdullai		
PRUJ Konstruktore	Ing.	Haxhi Avdullai		
PRUJ ARKITEKTONIK	Ark.	Erald TAVANXHIU		
TOPOGRAF	GJ.	Isidor PRIFTI		
PROJEKTI	Bashkia FIER(QARKU FIER)			SHKURT 2025 BASHKIA FIER

**PROFILAT TERTHOR I SEGMENTIT TE RRUGES
QENDER DARZEZE - BREGDETE (ANA LINDORE) SH.1:100**

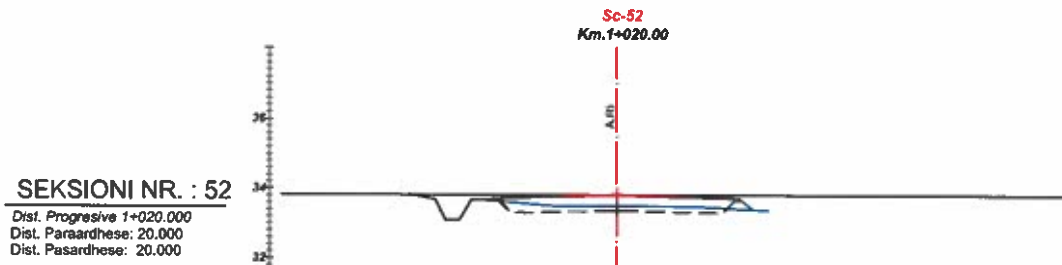

SEKSIONI NR. : 52
Dist. Progressive 1+020.000
Dist. Paraardhese: 20.000
Dist. Pasardhese: 20.000

Kouta ref.30.00

Kuota Terrenit		33.79	33.53	33.51	33.50	33.39
Progresiva Terrenit		-3.88	-1.81	0.00	2.18	4.28
Kuota Projektit		3.00	3.00	3.00	3.00	3.00
Progresiva Projektit	Kanal	0.50	0.50	0.00	0.50	0.50
		Bankin	RRUGA	RRUGA	RRUGA	Bankin



Gjermi i trupit te rruges kazonale	1.124 m ²
Mbushje me Cakull(zhevor)	0.388 m ²

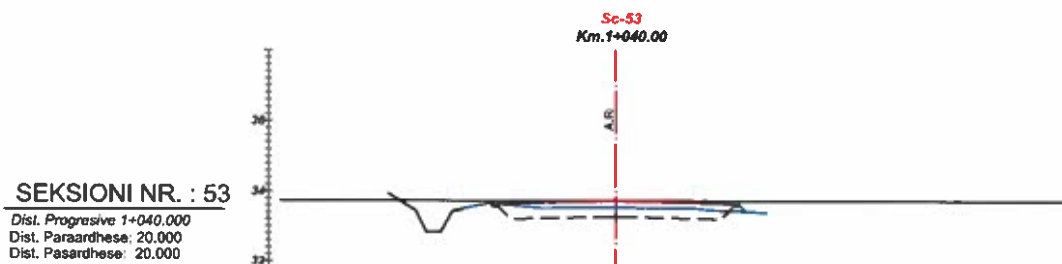

SEKSIONI NR. : 53
Dist. Progressive 1+040.000
Dist. Paraardhese: 20.000
Dist. Pasardhese: 20.000

Kouta ref.30.00

Kuota Terrenit		33.58	33.54	33.41	33.37	33.31	33.28	33.27
Progresiva Terrenit		-4.16	-3.57	-2.08	-0.94	0.00	2.22	4.28
Kuota Projektit		3.00	3.00	3.00	3.00	3.00	3.00	3.00
Progresiva Projektit	Kanal	0.50	0.50	0.50	0.50	0.00	0.50	0.50
		Bankin	RRUGA	RRUGA	RRUGA	RRUGA	RRUGA	Bankin

Gjermi i trupit te rruges kazonale	1.789 m ²
Mbushje me Cakull(zhevor)	0.047 m ²

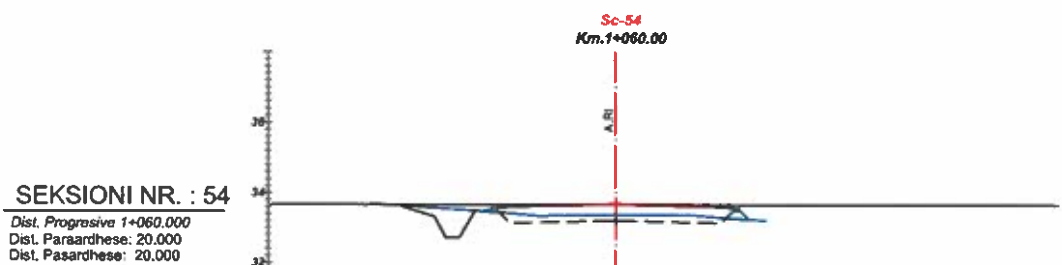

SEKSIONI NR. : 54
Dist. Progressive 1+060.000
Dist. Paraardhese: 20.000
Dist. Pasardhese: 20.000

Kouta ref.30.00

Kuota Terrenit		33.52	33.43	33.35	33.37	33.35	33.28	33.22
Progresiva Terrenit		-4.37	-3.12	-2.17	0.00	2.26	3.24	4.25
Kuota Projektit		3.00	3.00	3.00	3.00	3.00	3.00	3.00
Progresiva Projektit	Kanal	0.50	0.50	0.50	0.00	0.50	0.50	0.50
		Bankin	RRUGA	RRUGA	RRUGA	RRUGA	RRUGA	Bankin

Gjermi i trupit te rruges kazonale	1.138 m ²
Mbushje me Cakull(zhevor)	0.122 m ²

RIKONSTRUKSIONI RRUGES NGA QENDRA DARZEZE - BREGDETE (ANA LINDORE)		PLETA K-48
PROJ. KONSTRUKTOR	Ing. Haxhi Avdullai	
PROJ. ARKITEKTONIK	Ark. Erald TAVANXHIU	
TOPOGRAF	GJ. Ilisidor PRIFTI	
POROSIT	Bashkia FIER(QARKU FIER)	
		PROJEKT TERTHORE (PRISQ-54) SHKURT 2025 BASHKIA FIER

PROFILAT TERTHOR I SEGMENTIT TE RRUGES QENDER DARZEZE - BREGDETE (ANA LINDORE) SH.1:100

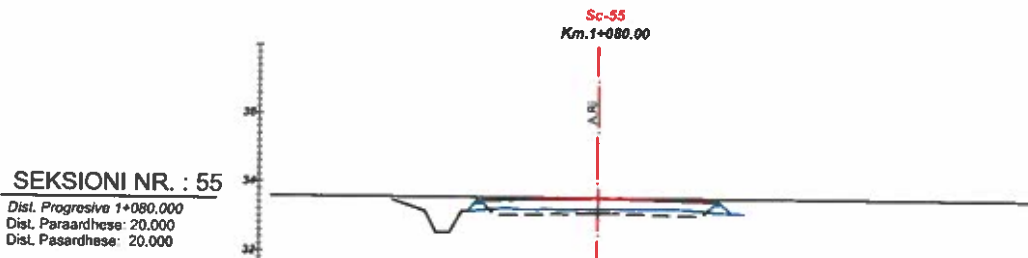

SEKSIONI NR. : 55
Dist. Progressive 1+080.000
Dist. Paraardhese: 20.000
Dist. Pasardhese: 20.000



Kouta ref.30.00

Kuota Terrenit		33.43	33.25	33.27	33.28	33.28	33.16	33.14
Progressiva Terrenit		-4.58	-2.26	0.00	1.42	2.30	3.78	4.23
Kuota Projektit				33.28				
Progressiva Projektit	Kanal	0.50	3.00	0.00	3.00	0.50		
		Bankin				Bankin		

Gjermani i trupit te rruges kasonate	1.024 m ²
Mbushje me Calull(zhvorr)	0.202 m ²



SEKSIONI NR. : 56
Dist. Progressive 1+100.000
Dist. Paraardhese: 20.000
Dist. Pasardhese: 20.000

Kouta ref.30.00

Kuota Terrenit		33.29	33.24	33.11	33.11	33.14	33.14	33.05
Progressiva Terrenit		-6.02	-4.92	-3.28	0.00	0.64	3.64	4.78
Kuota Projektit				33.45				
Progressiva Projektit	Kanal	0.50	3.00	0.00	3.00	0.50		
		Bankin				Bankin		

Gjermani i trupit te rruges kasonate	0.910 m ²
Mbushje me Calull(zhvorr)	0.156 m ²

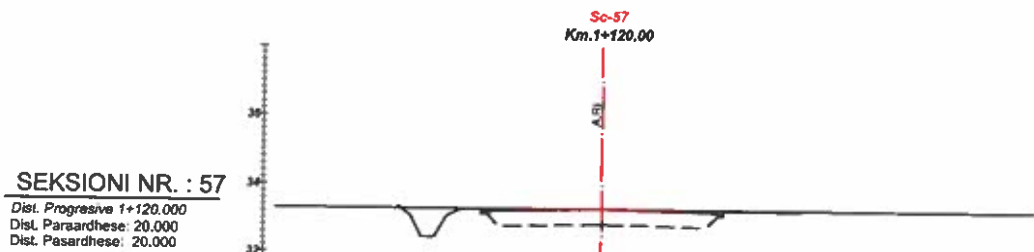

SEKSIONI NR. : 57
Dist. Progressive 1+120.000
Dist. Paraardhese: 20.000
Dist. Pasardhese: 20.000

Kouta ref.30.00

Kuota Terrenit		33.37	33.36	33.29	33.31	33.31	33.28	
Progressiva Terrenit		-5.90	-4.03	-0.84	0.00		5.78	
Kuota Projektit				33.32				
Progressiva Projektit	Kanal	0.50	3.00	0.00	3.00	0.50		
		Bankin				Bankin		

Gjermani i trupit te rruges kasonate	3.134 m ²
Mbushje me Calull(zhvorr)	0.000m ²

RKONSTRUKSIONI RRUGES NGA QENDRA DARZEZE - BREGDETE (ANA LINDORE)		FETA Km 49
PROJEKTUESI	Ing. Haxhi Avdullai	
PROJ. KONSTRUKTOR	Ing. Haxhi Avdullai	
PROJ. ARKITEKTONIK	Ark. Erahd TAVANXHIU	
TOPOGRAF	GJ. Isidor PRIFTI	
POKRETI	Bashkia FIER(QARKU FIER)	BASHKIA FIER

**PROFILAT TERTHOR I SEGMENTIT TE RRUGES
QENDER DARZEZE - BREGDETE (ANA LINDORE) SH.1:100**

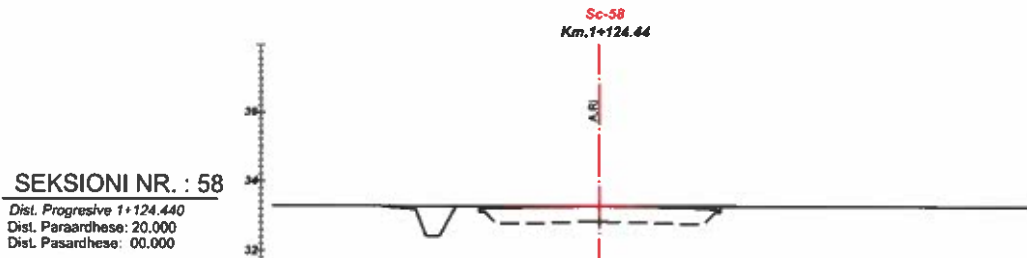

SEKSIONI NR. : 58
Dist. Progressive 1+124.440
Dist. Paraardhese: 20.000
Dist. Pasardhese: 00.000

Kouta ref.30.00

Kuota Terrenit		33.29		33.31	33.31
Progresiva Terrenit		0.00		3.01	3.47
Kuota Projektit		33.29		33.31	33.31
Progresiva Projektit	Kanal	0.50	3.00	3.00	0.50
		Banin	RRUGA	RRUGA	Banin

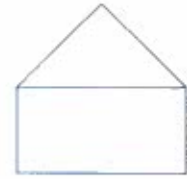

Gabim (kap) te rruges kazonete	3.185 m ²
Mbushje me Çatullzhevori	0.000 m ²

		RIKONSTRUKSIONI RRUGES NGA QENDRA DARZEZE - BREGDETE (ANA LINDORE)		FIGURA K-50
		Ing.	Haxhi Avdullai	
PROJ. KONSTRUKTOR	Ing.	Haxhi Avdullai		
PROJ. ARKITEKTONIK	Ark.	Enald TAVANXHIU		
TOPOGRAF	Gj.	Isidor PRIFTI		
PROJEKTI		Bashkia FIER(QARKU FIER)		
				SHKURT 2025 BASHKIA FIER

**PROFILAT TERTHOR I SEGMENTIT TE RRUGES
QENDER DARZEZE - BREGDETE (ANA LINDORE) SH.1:100**

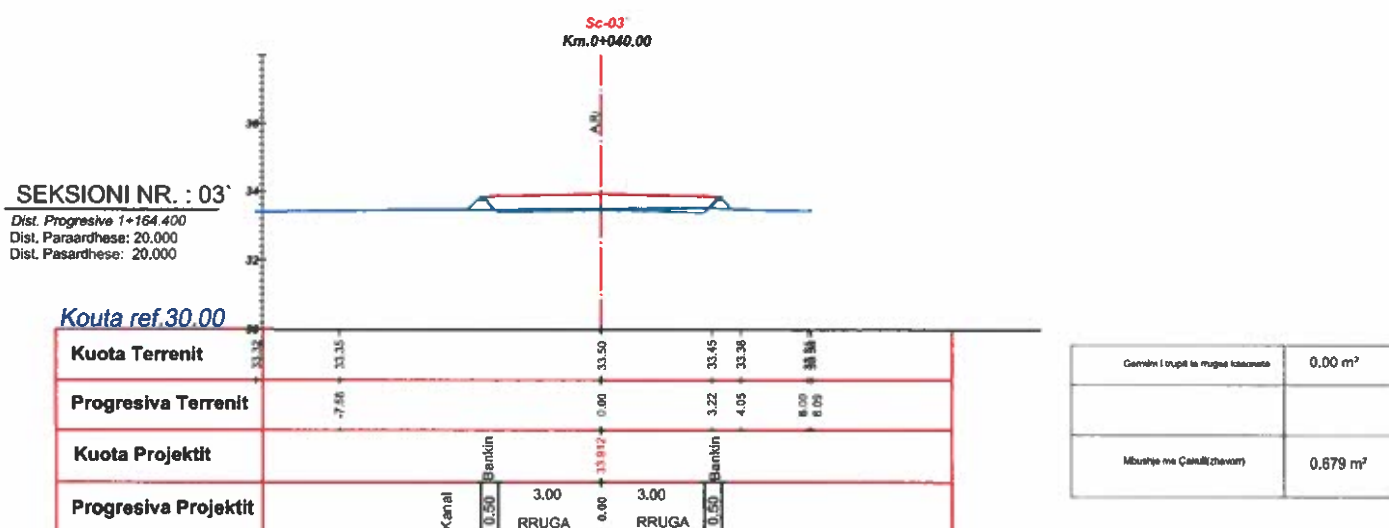
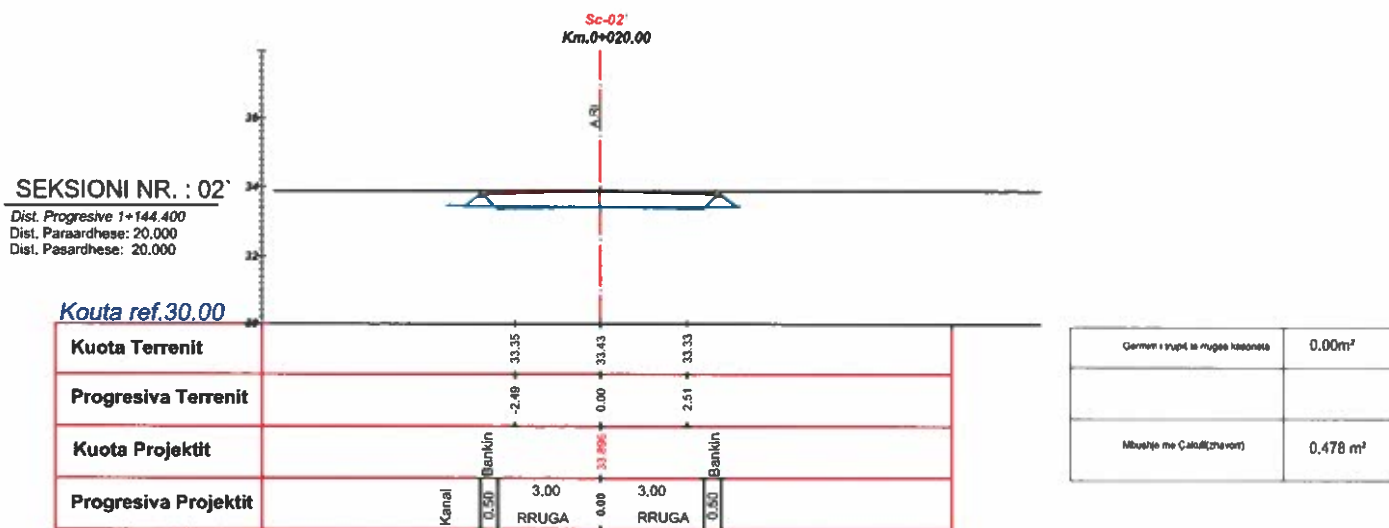
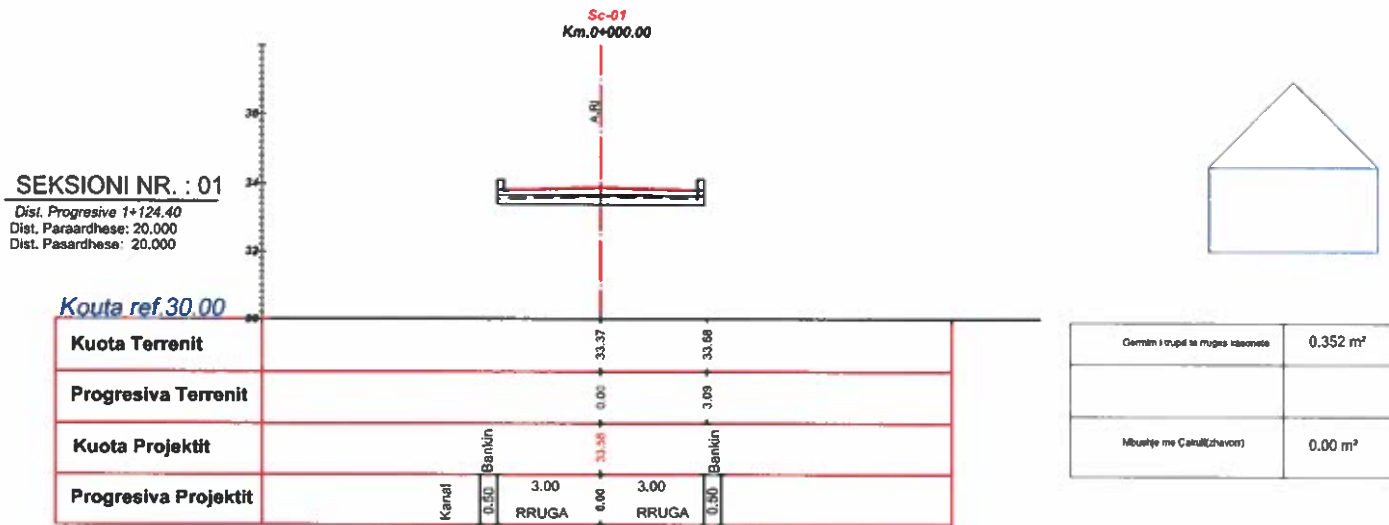

RIKONSTRUKSIONI RRUGES NGA QENDRA DARZEZE - BREGDETE (ANA LINDORE)		FLETA K-51	
PRIMI Konstruktor	Ing. Haxhi Avdullai		PRIFLET TERRITORE (PRLON-03)
PRIMI ARKITEKTONIK	Ark. Enald TAVANXHIU		SHKURT 2025
TUPOGRAF	GJ. Ilisudor PRIFTI		BASHKIA FIER
PRIMI	Bashkia FIER/QARKU FIER		

PROFILAT TERTHOR I SEGMENTIT TE RRUGES QENDER DARZEZE - BREGDETE (ANA LINDORE) SH.1:100

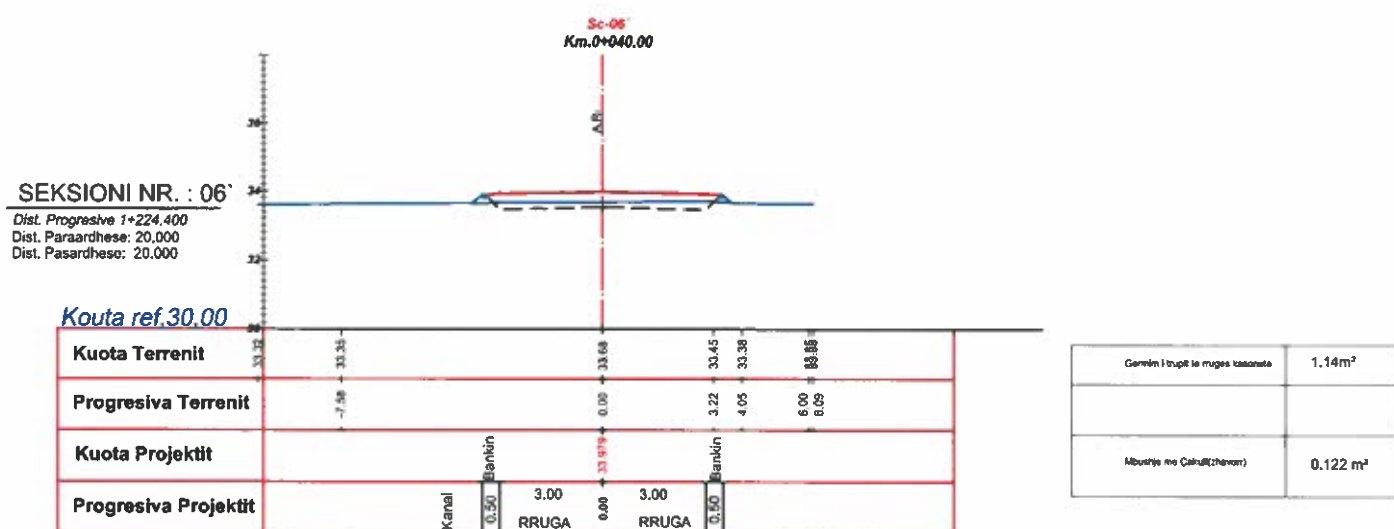
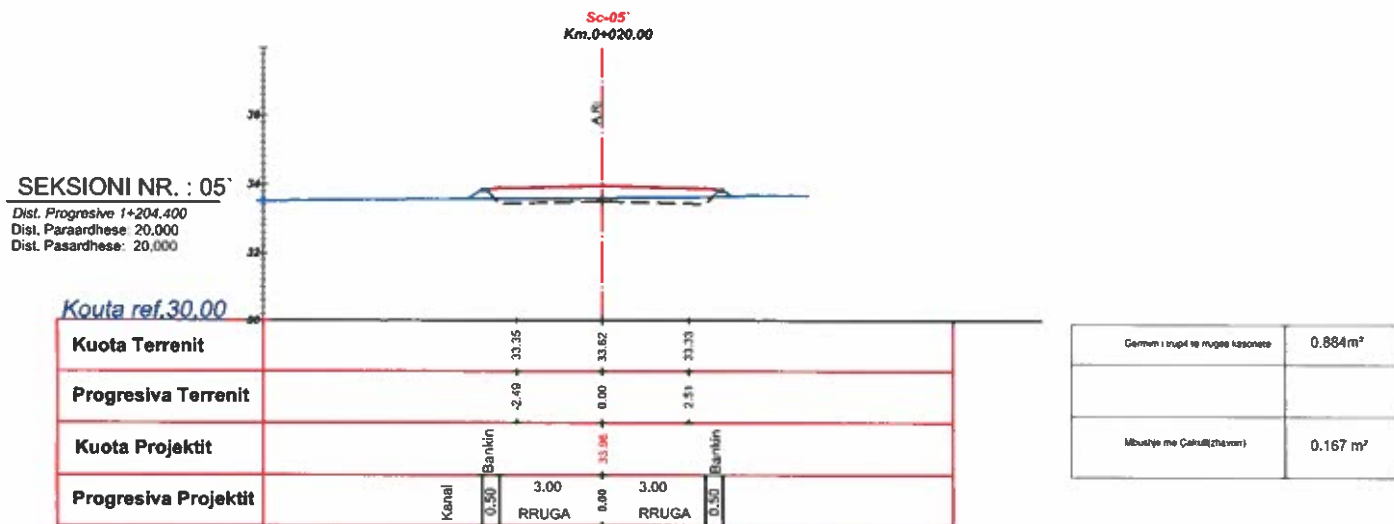
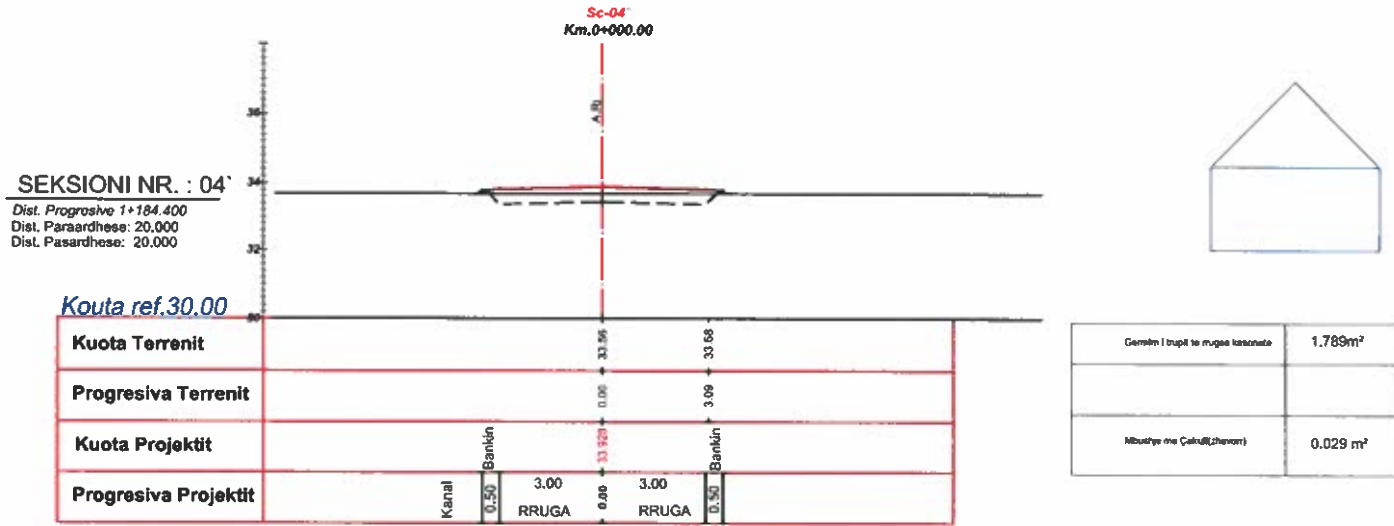

RIKONSTRUKSIONI RRUGES NGA QENDRA DARZEZE - BREGDETE (ANA LINDORE)		FLUTA K-52
PRILIDHJEVE TË PUNËSIAVE TË PUNËSIAVE TË PUNËSIAVE	Ing.	Haxhi Avdullah
PRUJ. Konstruktor	Ing.	Haxhi Avdullah
PRUJ. ARKITEKTONIK	Ark.	Enald TAVANXHIU
TOPOGRAFI	G.J.	Ihsudir PRIFTI
PROJEKTI	Bashkia FIER(QARKU FIER)	
		PROFILI TERTHOR (P&C01-03)
		SHKURT 2025
		BASHKIA FIER

**PROFILAT TERTHOR I SEGMENTIT TE RRUGES
QENDER DARZEZE - BREGDETE (ANA LINDORE) SH.1:100**

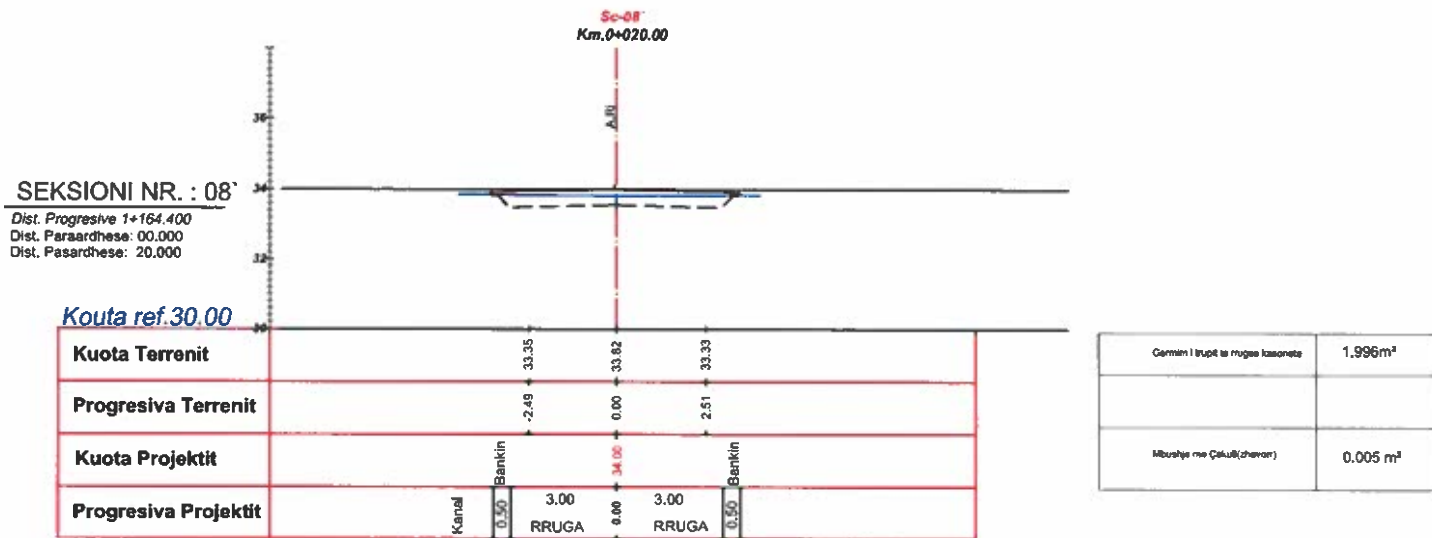
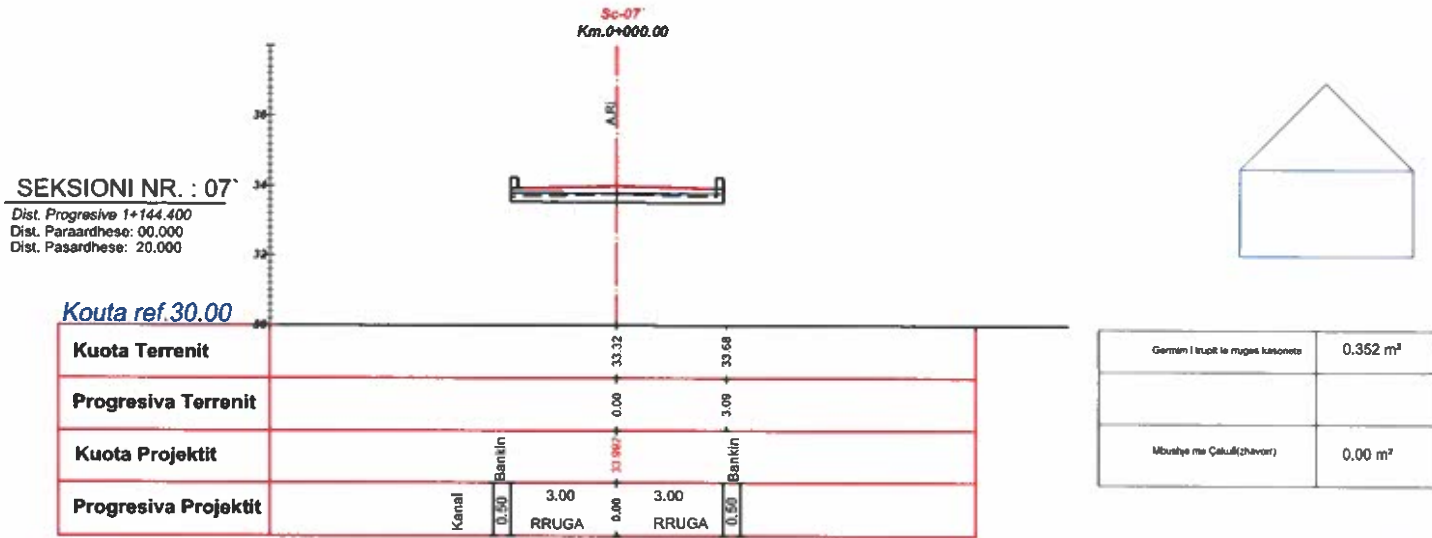

**RIKONSTRUKSIONI RRUGES
NGA QENDRA DARZEZE - BREGDETE
(ANA LINDORE)**

**PLAN
K-53**

PROJEKTUESI	Ing. Haxhi Avdulla
PROJ. KONSTRUKTOR	Ing. Haxhi Avdulla
PROJ. ARKITEKTURIK	Ark. Enxhida TAVANXHIU
TOPOGRAF	G.L. Isidor PRIFTI
POSICIONI	Bashkia FIER(QARKU FIER)

SHKURT 2025
BASHKIA FIER

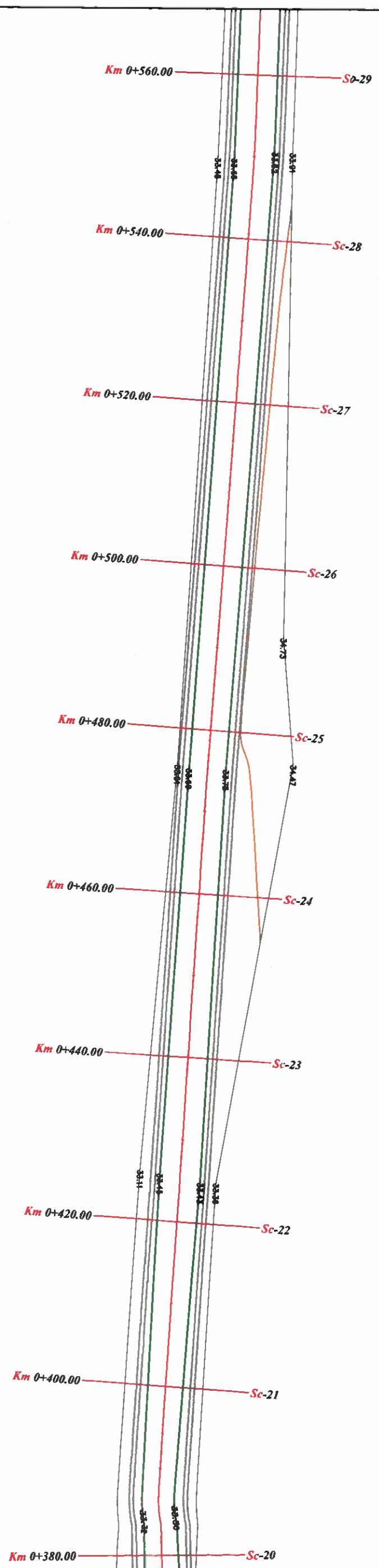

TOPOGRAFIA E RIKONSTRUKSIONIT TE SEGMENTIT TE RRUGES
 NGA QENDRA DARZEZE DERI NE BREGDET(ANA LINDORE) SH 1:500

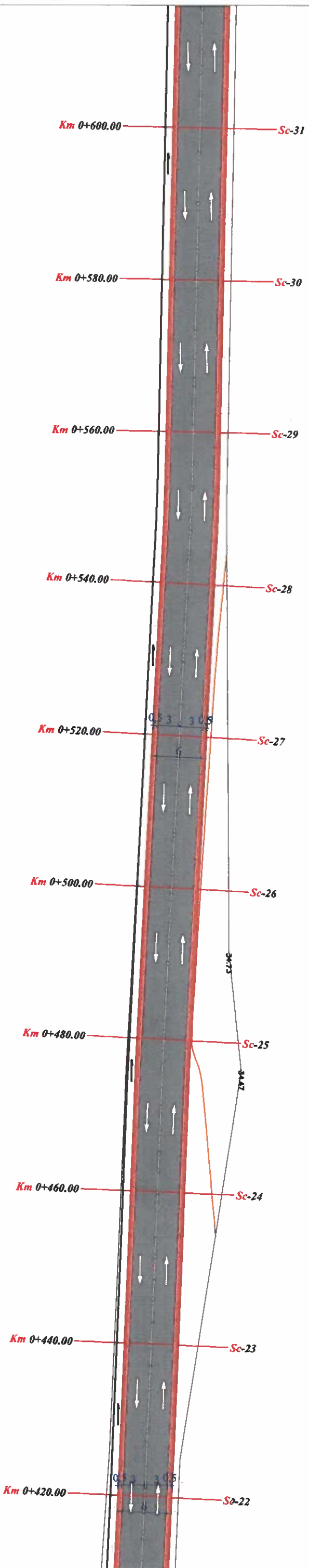

 <p>RIKONSTRUKSIONI RRUGES NGA QENDRA DARZEZE - BREGDETE (NE LINDJE)</p>		<p>FLFTA K-05</p>	
		<p>TOPOGRAFIA PLANIMETRIA PIK.20-29</p>	
<p>DIREKTORINSE SI PROJEKTIVIT TE PROJEKTIMIT</p>		<p>Ing. Haxhi Avdullai</p>	<p>Ing. Haxhi Avdullai</p>
<p>Proj. Konstruktor</p>		<p>Ark. Erajd TAVANXHIU</p>	<p>Ark. Erajd TAVANXHIU</p>
<p>Proj. ARKITEKTONIK</p>		<p>Gj. Ilisidor PRIFTI</p>	<p>Gj. Ilisidor PRIFTI</p>
<p>TOPOGRAF</p>		<p>Bashkia FIER(QARKU FIER)</p>	
<p>POROSIT</p>		<p>BASHKIA FIER</p>	

SINJALISTIKA E RIKONSTRUKSIONIT TE SEGMENTIT TE RRUGES
 NGA QENDRA DARZEZE DERI NE BREGDET
 (ANA LINOBE) SH 1:100



		RIKONSTRUKSIONI RRUGES		PLETA
		NGA QENDRA DARZEZE - BREGDET		
NGA QENDRA DARZEZE (NE LINDJE)		Ing.	Haathi Avdullai	
Proj. Konstruktor	Ing.	Haathi Avdullai	SMALISTRKA	
Proj. ARKITEKTONIK	Ark.	Erail TAVANXHILU	PK.22-31	
Topografi	GSJ	Ilisidor PRUFTI	04.ETOR 2024	
Porositi	Bashkia FIER(QARKU FIER)		BASHKIA FIER	

SINJALISTIKA E RIKONSTRUKSIONIT TE SEGMENTIT TE RRUGES
 NGA QENDRA DARZEZE DERI NE BREGDET
 (ANA LINORE) SH 1:100

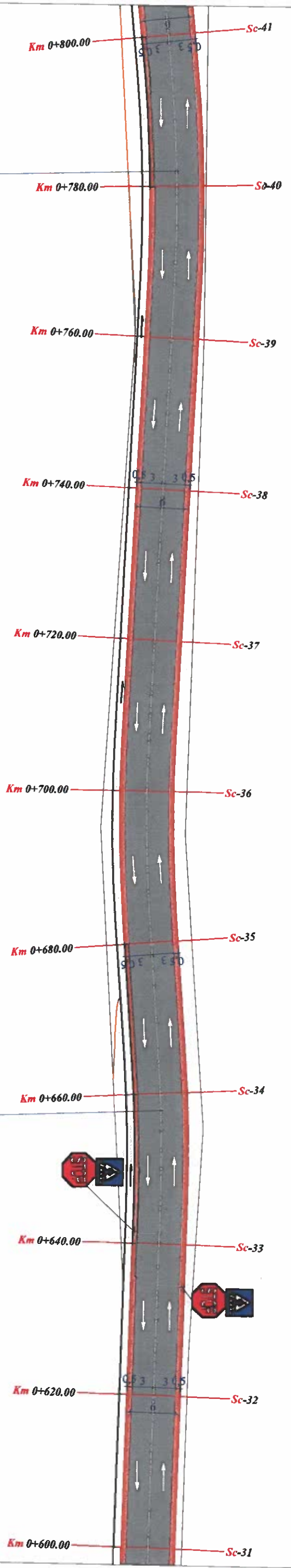

 RIKONSTRUKSIONI RRUGES NGA QENDRA DARZEZE DERI NE BREGDET (NE LINDE)		Ing.	Haxhi Avdullai	PLANI K-23
		Ing.	Haxhi Avdullai	
Proj. Konstruktor Proj. ANKUTR/TONIK		Ark.	Enlid TAVANXHIU	SHIKIMISTKA PK-31-41
Topograf HODOSITI		Gj.	Isidor PRUFTI	
Bashkia FIER(QARKU FIER)				DATUMI 2024 BASHKIA FIER

SINJALISTIKA E RIKONSTRUKSIONIT TE SEGMENTIT TE RRUGES
 NGA QENDRA DARZEZE DERI NE BREGDET
 (ANA LINORE) SH 1:100

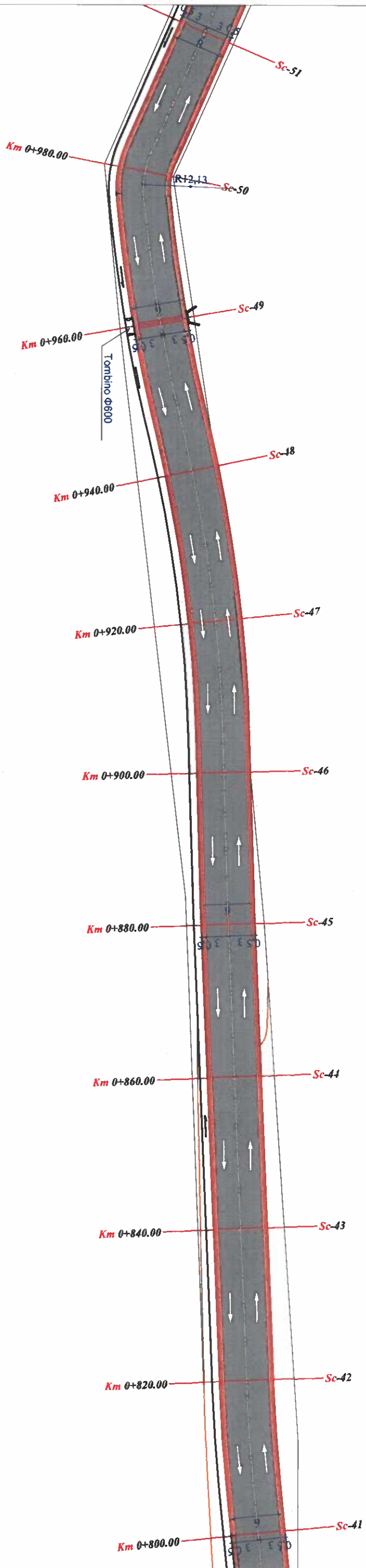

 <p>RIKONSTRUKSIONI RRUGES NGA QENDRA DARZEZE - BREGDETE (NE UNDE)</p>		<p>FLTA K-24</p>	
		<p>SMALJSTKA PK.41-51</p>	
<p>Proj. Konstruktor</p>	<p>Inj. Haxhi Avdullahi</p>	<p>Proj. Arkitet/Inj.</p>	<p>Inj. Haxhi Avdullahi</p>
<p>Topograf</p>	<p>Ark. Enid TAVANXHILU</p>	<p>Gj. Ihsidor PRUFTI</p>	<p>Ark. Enid TAVANXHILU</p>
<p>Porosim</p>	<p>Bashkia FIER(QARKU FIER)</p>	<p>Dhjetor 2024</p>	<p>BASHKIA FIER</p>

**SINJALISTIKA E RIKONSTRUKSIONIT TE SEGMENTIT TE RRUGES
NGA QENDRA DARZEZE DERI NE BREGDET
(ANA LINOIRE) SH 1:100**

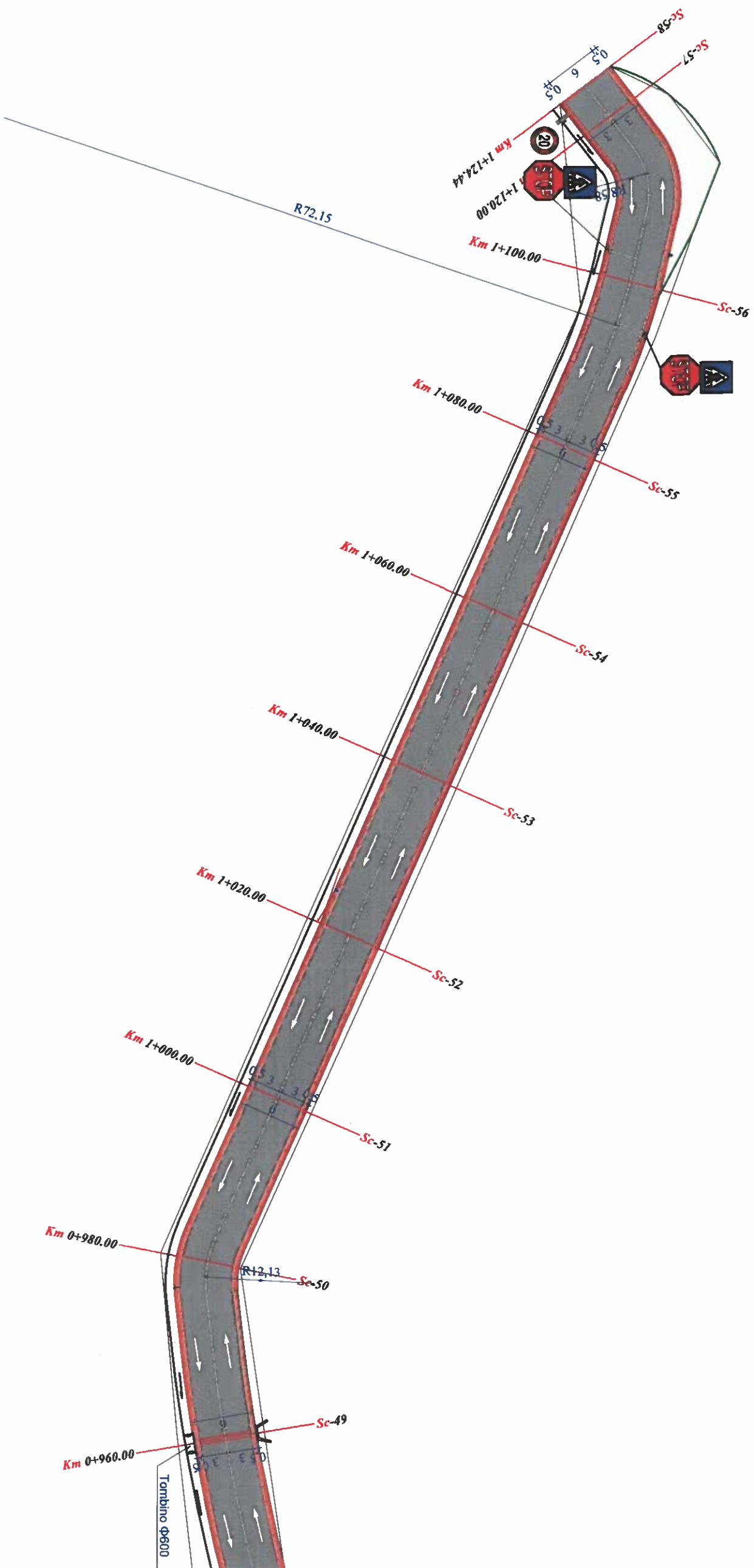

		RIKONSTRUKSIONI RRUGES NGA QENDRA DARZEZE - BREGDETE (NE LINDJE)		PLATA K-25	
		Ingj.	Hashti Avdullai	SHKURTIMET	PK.48-58
PROJ. KONSTRUKTOR	Ingj.	Hashti Avdullai	PROJ. ANKONIMET	Ark.	Enal TAVANXHIU
TOPOGRAFI	Gj.	Ilisidor PRIFTI	PRILIDHJE	Gj.	Ilisidor PRIFTI
PROJEKTI	Bashkia FIER(QARKU FIER)				DHJETOR 2024
PROJEKTI	Bashkia FIER(QARKU FIER)				BASHKIA FIER



**PROFILI GJATSORE I RIKONSTRUKSIONIT TE SEGMENTIT TE RRUGES
NGA QENDRA DARZEZE DERI NE BREGDET SH 1:1000**

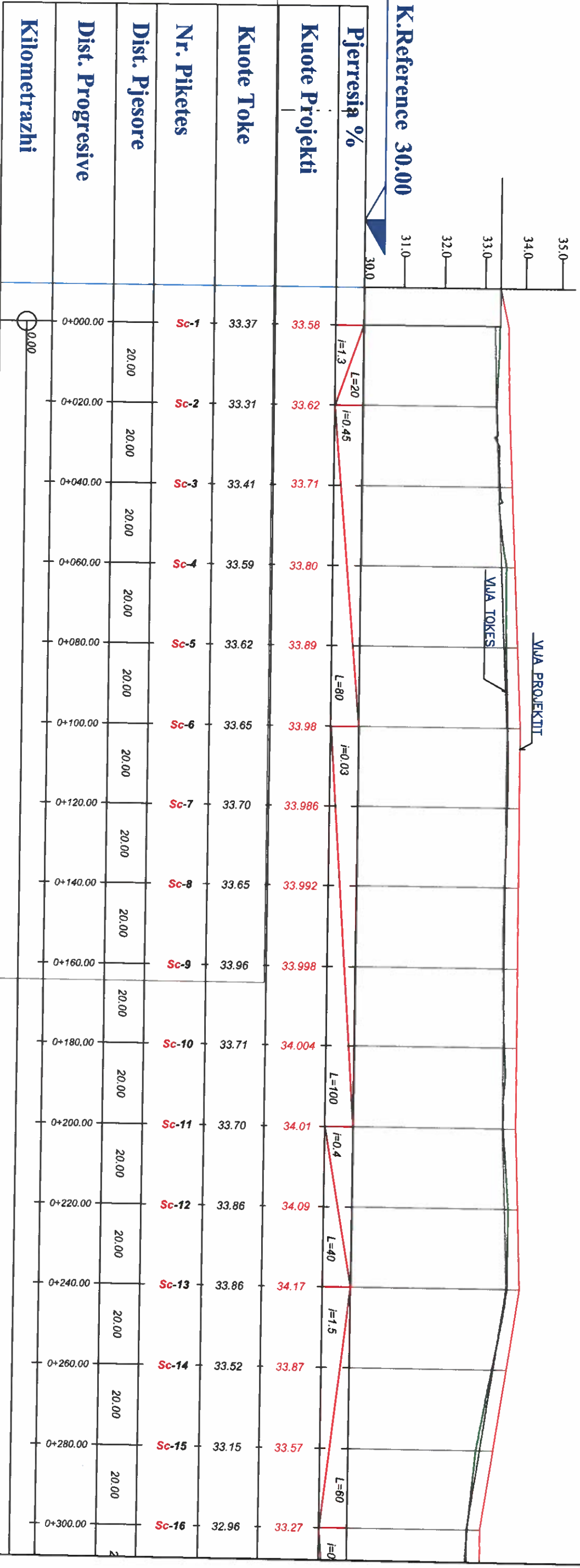

		RIKONSTRUKSIONI RRUGES NGA QENDRA DARZEZE - BREGDET (NE LINDJE) (NE LINDJE)		FLETA K-26	
DIREKTORIN E PROJEKTEVE TE INZHINIERIAVE	PROJ. KONSTRUKTOR	ING.	Haxhi Avdullai	PROFILI GJATSOR PK.01-16	DATETOR 2024
PROJ. ARKITEKTONIK	ARK.	ING.	Erald TAVANXHIU		
TOPOGRAFI	GJ.	GJ.	Ilsidor PRIFTI		
POROSITI	Bashkia FIER (QARKU FIER)			DATETOR 2024	BASHKIA FIER

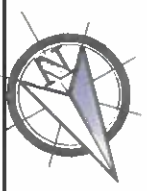

**PROFILI GJATSORE I RIKONSTRUKSIONIT TE SEGMENTIT TE RRUGES
NGA QENDRA DARZEZE DERI NE BREGDET SH 1:1000**

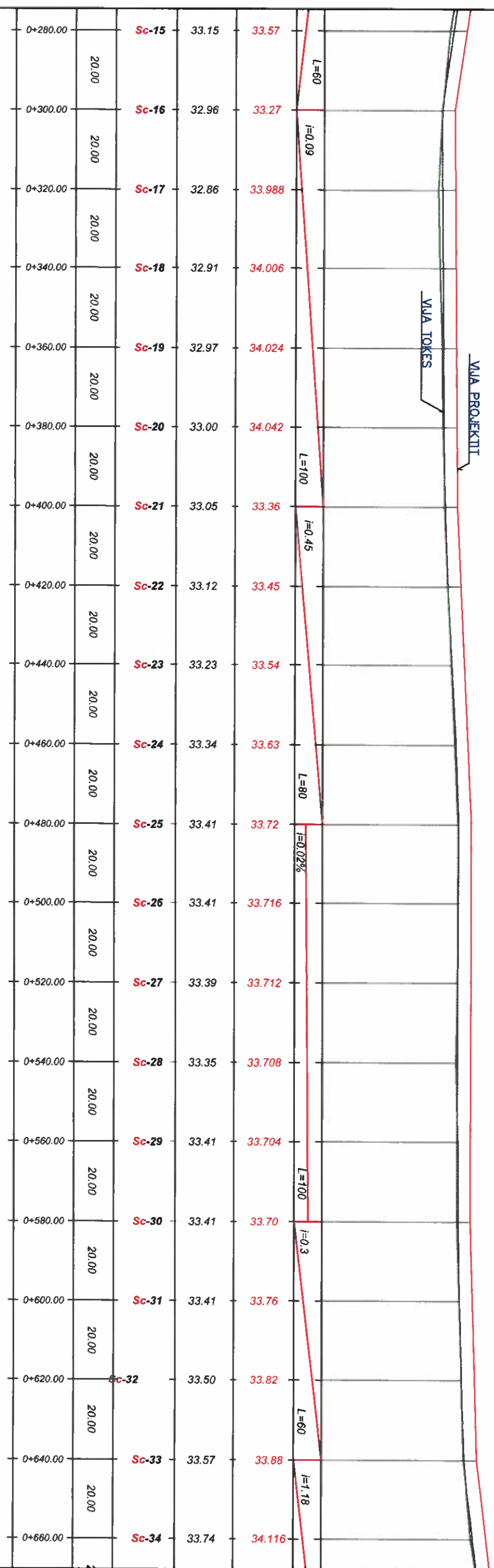

		RIKONSTRUKSIONI RRUGES NGA QENDRA DARZEZE - BREGDET (NE LINDJE)	
DR. DHEJTRIM SH. BRIGJENTINI INZHINJER I TIT Proj. Konstruktor Proj. Arkitektonek TOPOGRAF POROSITI	Inj. Inj. Ark. Gj. Bashkia FIER (QARKU FIER)	Haxhi Avdullai Haxhi Avdullai Erald TAVANXHIU Ihsidor PRIFTI Bashkia FIER (QARKU FIER)	Inj. Inj. Ark. Gj. Bashkia FIER (QARKU FIER)
FLETA K-27		PROFILI GJATSORE PK.16-34 DHJETOR 2024 BASHKIA FIER	



**PROFILI GJATSORE I RIKONSTRUKSIONIT TE SEGMENTIT TE RRUGES
NGA QENDRA DARZEZE DERI NE BREGDET SH 1:1000**

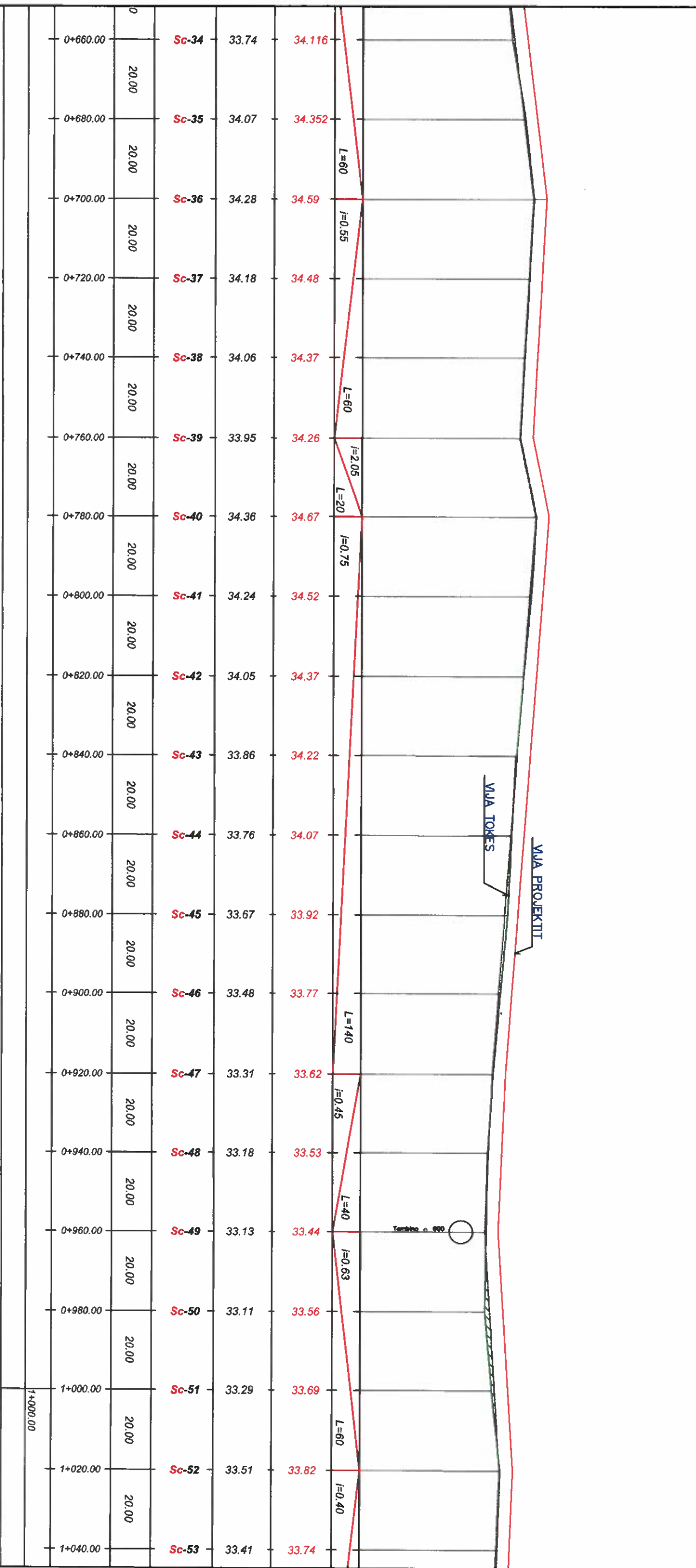

 RIKONSTRUKSIONI RRUGES NGA QENDRA DARZEZE – BREGDET (NE LINDJE)		FETA K-28	
DI DREKTORIN E PROJEKTEUTIT DIPLOMUE	Ing.	Ing.	Ing.
PROJ. KONSTRUKTOR	Haxhi Avdullai	Haxhi Avdullai	Haxhi Avdullai
PROJ. ARKITEKTONIK	Ark.	Ark.	Ark.
TOPOGRAF	Gj.	Gj.	Gj.
PORSITI	Bashkia FIER(QARKU FIER)		DHALETOR 2024
Bashkia FIER			PROFILI GJATSOR PIK.34-53



**PROFILI GJATSORE I RIKONSTRUKSIONIT TE SEGMENTIT TE RRUGES
NGA QENDRA DARZEZE DERI NE BREGDET SHI 1:1000**

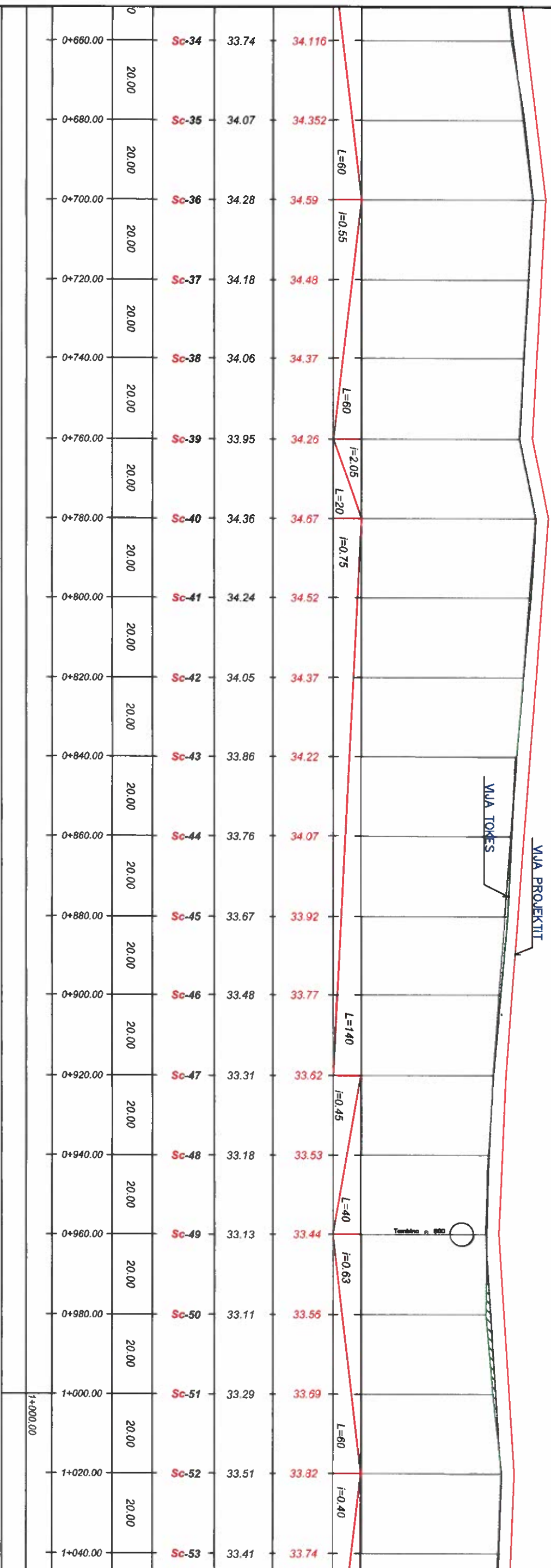

 RIKONSTRUKSIONI RRUGES NGA QENDRA DARZEZE – BREGDETE (NE LINDJE)		FLETA K-29	
DIREKTORIN E PROJEKTEVE E TJE INZHINJERINJER	Ing.	Haxhi Avdullai	 PROFILI GJATSORE PK.34-53
PROJ. KONSTRUKTOR	Ing.	Haxhi Avdullai	
PROJ. ARKITEKTONIK	Ark.	Erald TAVANXHIU	
TOPOGRAF	Gj.	Lisidor PRIFTI	DHETOR 2024
POROSITI	Bashkia FIER(QARKU FIER)		BASHKIA FIER



PROFILI GJATSORE I RIKONSTRUKSIONIT TE SEGMENTIT TE RRUGES
 NGA QENDRA DARZEZE DERI NE BREGDET SH 1:1000

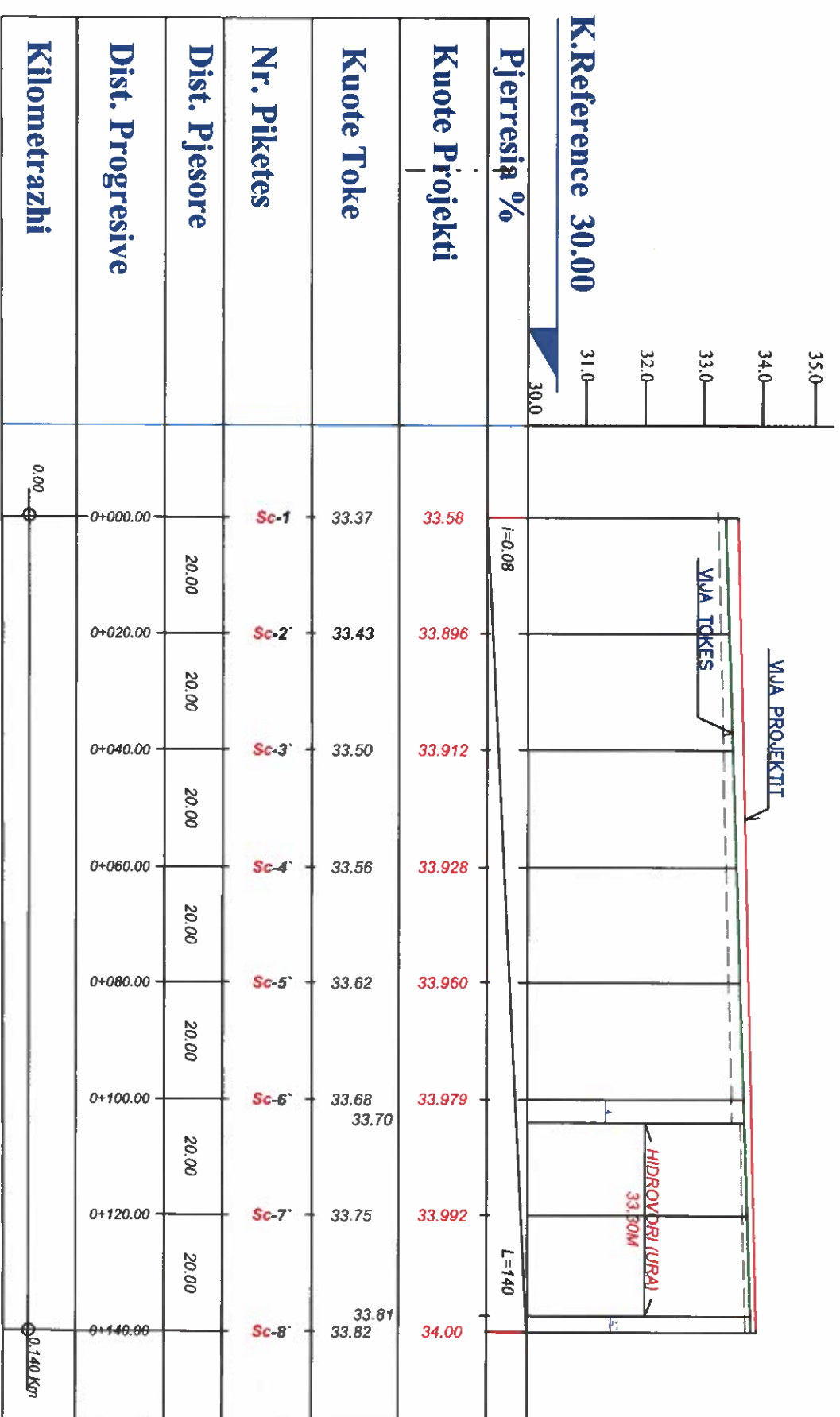
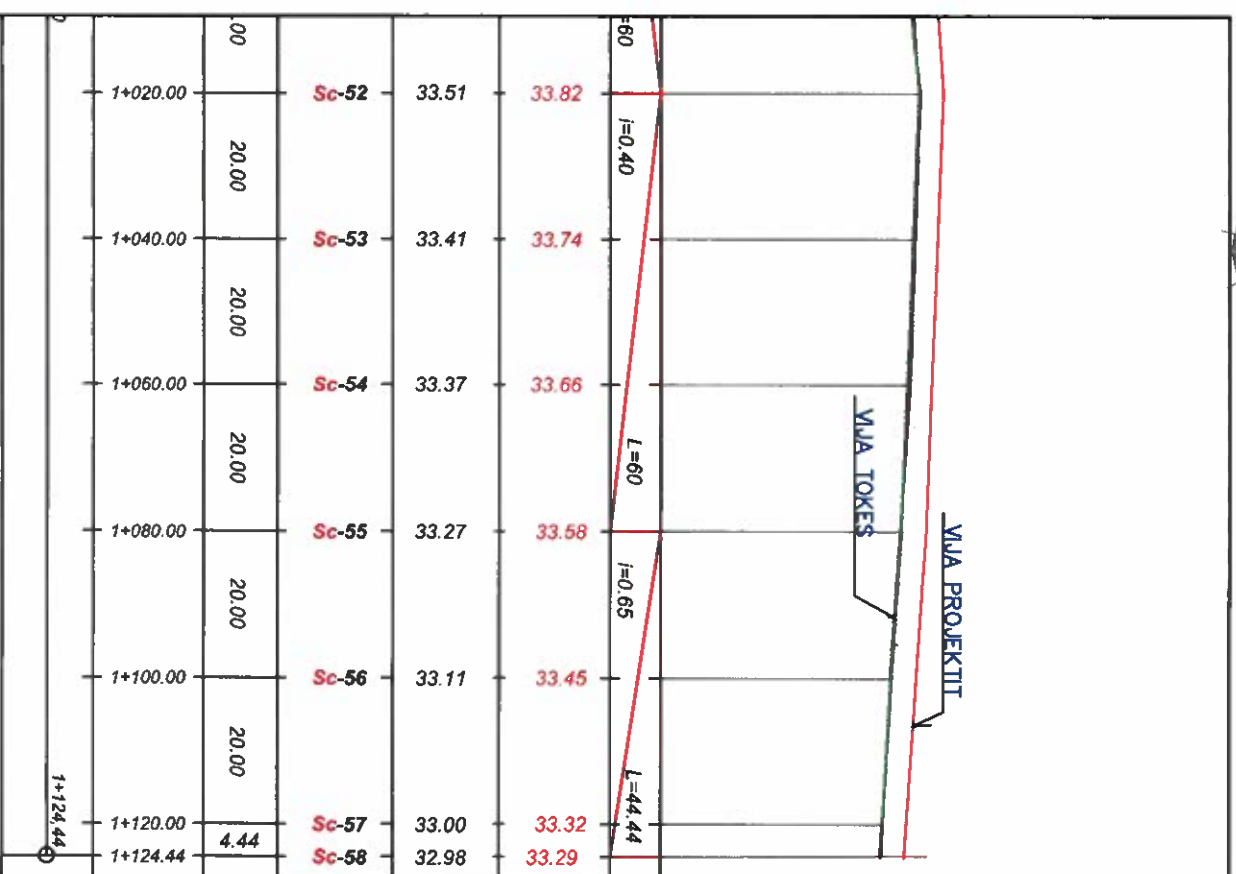

K.Reference 30.00

Pjerrësia %

Kuote Projekti

Kuote Tokë

Nr. Piketes

Dist. Pjesore



Dist. Progressive

Kilometrazhi

		RIKONSTRUKSIONI RRUGES NGA QENDRA DARZEZE - BREGDET (NE LINDJE)		FLETA K-30	
DIBOZITIMET E PROJEKTEVE TE INZHINIERIAVE	Inj. Haxhi Avdullai	PROFI GJATSOR PIK.34-53	Inj. Haxhi Avdullai	DHEJTOR 2024	BASHKIA FIER
PROI. Konstruktor	Ark. Eraid TAVANXXHIU	PROI. ARKITEKTONIK	Inj. Eraid TAVANXXHIU	DHEJTOR 2024	BASHKIA FIER
TOPOGRAF	G.J. Ihsidor PRIFTI	POROSITI	Bashkia FIER(QARKU FIER)	DHEJTOR 2024	BASHKIA FIER

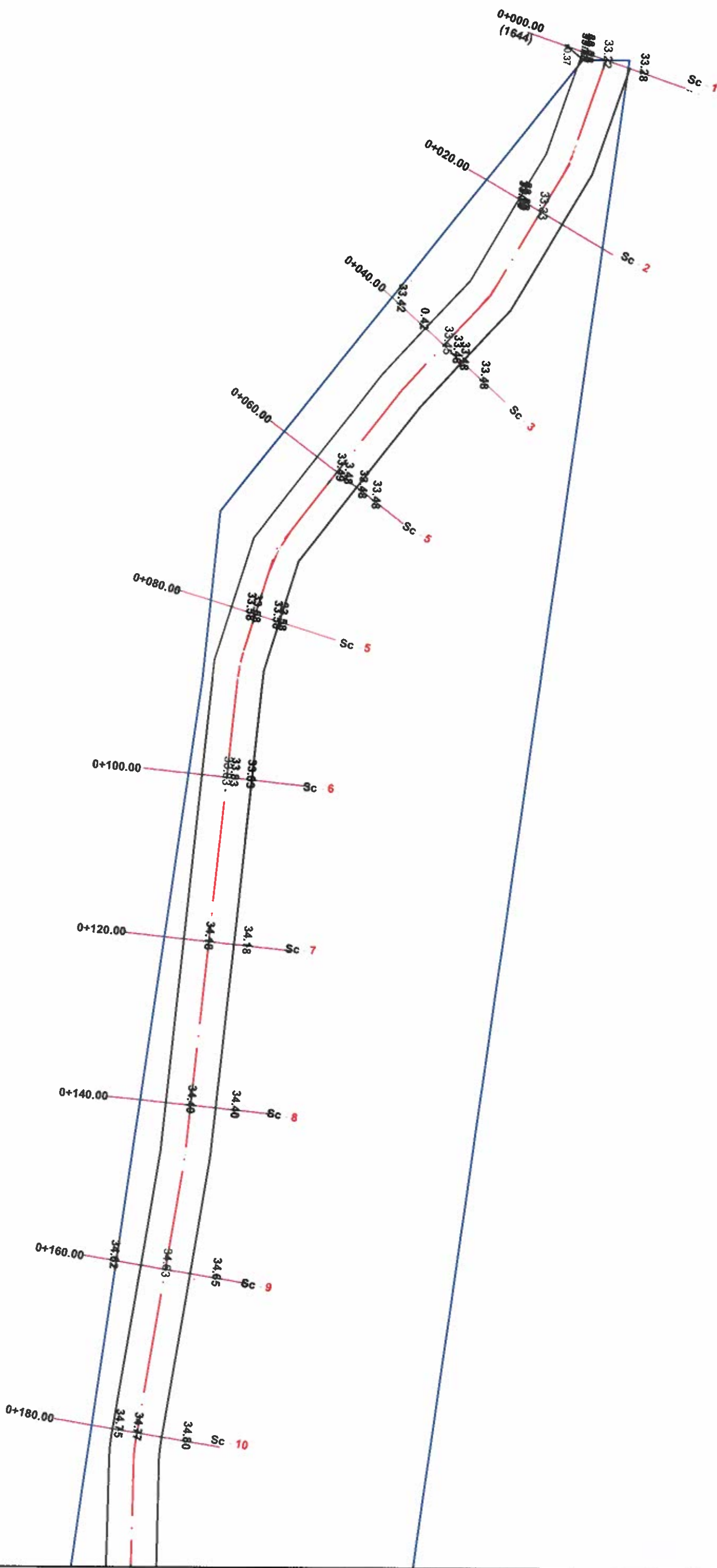
TOPOGRAFIA E RIKONSTRUKSIONIT TE SEGMENTIT TE RRUGES
 NGA QENDRA DARZEZE DERI NE BREGDET ANA PERNDIMORE SH 1:500



 <p>RIKONSTRUKSIONI RRUGES NGA QENDRA DARZEZE - BREGDET(Perendimor)</p>		<p>FLETA K-02</p>	
		<p>PLANIMETRIA PK.01-10</p>	
<p>DEPARTIMETI I INFRASHTRUKTURAS</p>		<p>Ing. Haxhi Avdullai</p>	
<p>PROJ. KONSTRUKTOR</p>		<p>Ing. Haxhi Avdullai</p>	
<p>PROJ. ARKITEKTONIK</p>		<p>Ark. Erajd TAVANXHIU</p>	
<p>TOPOGRAFI</p>		<p>G.J. Ilisidor PRIFTI</p>	
<p>POROSITI</p>		<p>Bashkia FIER(QARKU FIER)</p>	
		<p>SHIKURT 2025</p>	
<p>BASHKIA FIER</p>		<p>BASHKIA FIER</p>	

TOPOGRAFIA E RIKONSTRUKSIONIT TE SEGMENTIT TE RRUGES
 NGA QENDRA DARZEZE DERI NE BREGDET ANA PERNDIMORE SH 1:500

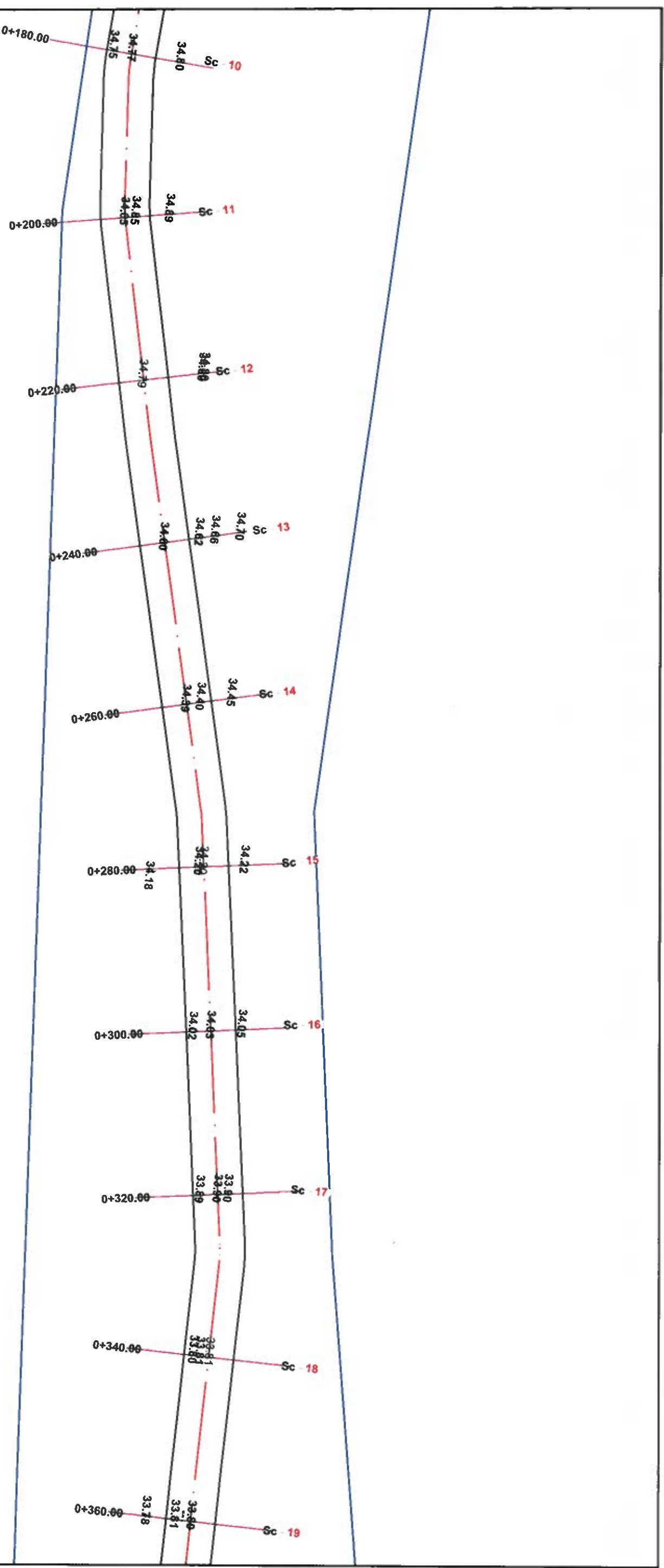

 <p>RIKONSTRUKSIONI RRUGES NGA QENDRA DARZEZE – BREGDET(Patendim)</p>		<p>FLETA K-03</p>	
		<p>PLANIMETRIA PIK:10-19</p>	
DEPARTIMETI I INFRASHTRUKTURAVE	Ing.	Haxhi Avdullai	
Proi Konstruktor	Ing.	Haxhi Avdullai	
Proi ARKITEKTONIK	Ark.	Eraid TAVANXHIU	Bashkia FIER(QARKU FIER)
TOPOGRAF	G.J.	Ilisidor PRIFTI	
POROSITI	Bashkia FIER(QARKU FIER)		SHKURT 2025 BASHKIA FIER

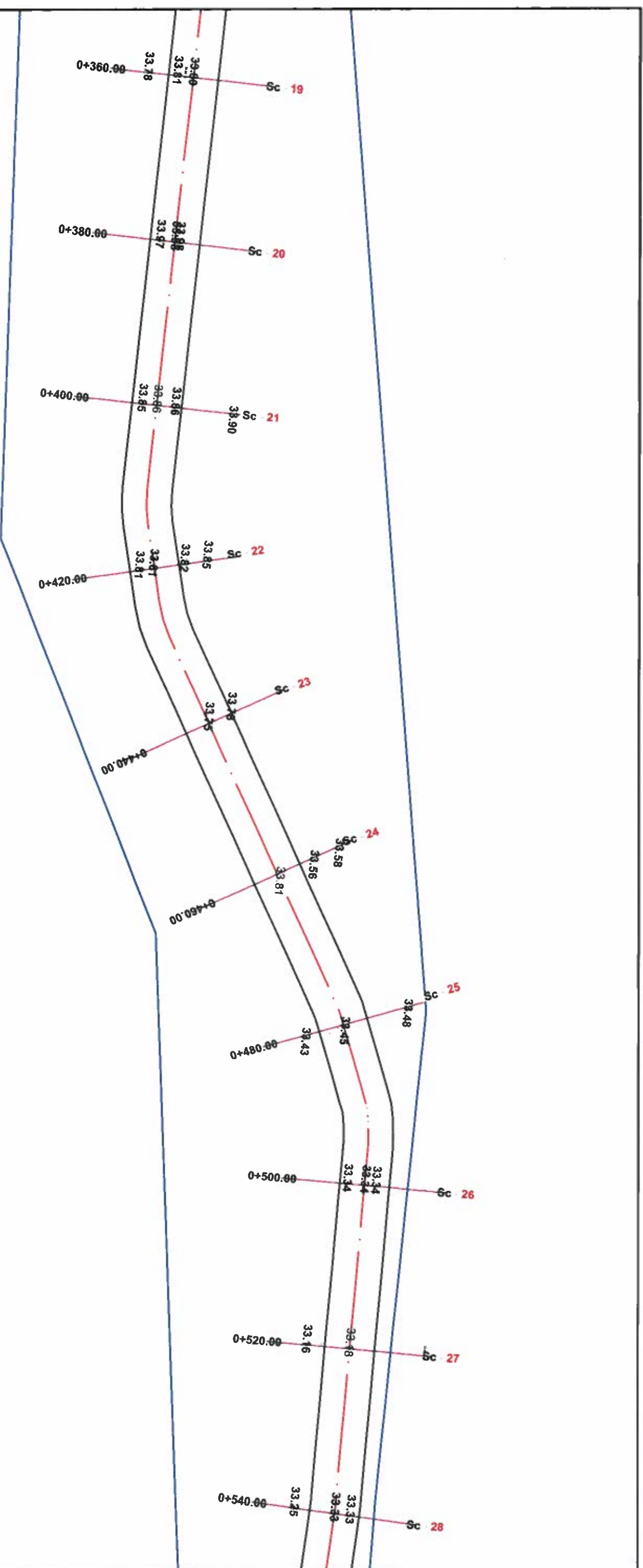

TOPOGRAFIA E RIKONSTRUKSIONIT TE SEGMENTIT TE RRUGES
 NGA QENDRA DARZEZE DERI NE BREGDET ANA PERNDIMORE SH 1:500



		RIKONSTRUKSIONI RRUGES		FLETA K-04
		NGA QENDRA DARZEZE - BREGDET (Parandim)		
DR. BURETORGJESHE E PROJEKTIMEVE TE INZHENERIAVE		Ing.	Haxhi Avdullai	PLANIMETRIA PIK.19-28
Proi Konstruktor		Ing.	Haxhi Avdullai	
Proi ARKITEKTONIK		Ark.	Eraild TAVANXHIU	
TOPOGRAF		G.J.	Ilisidor PRIFTI	SHKURT 2025
POROSITI		Bashkia FIER(QARKU FIER)		BASHKIA FIER

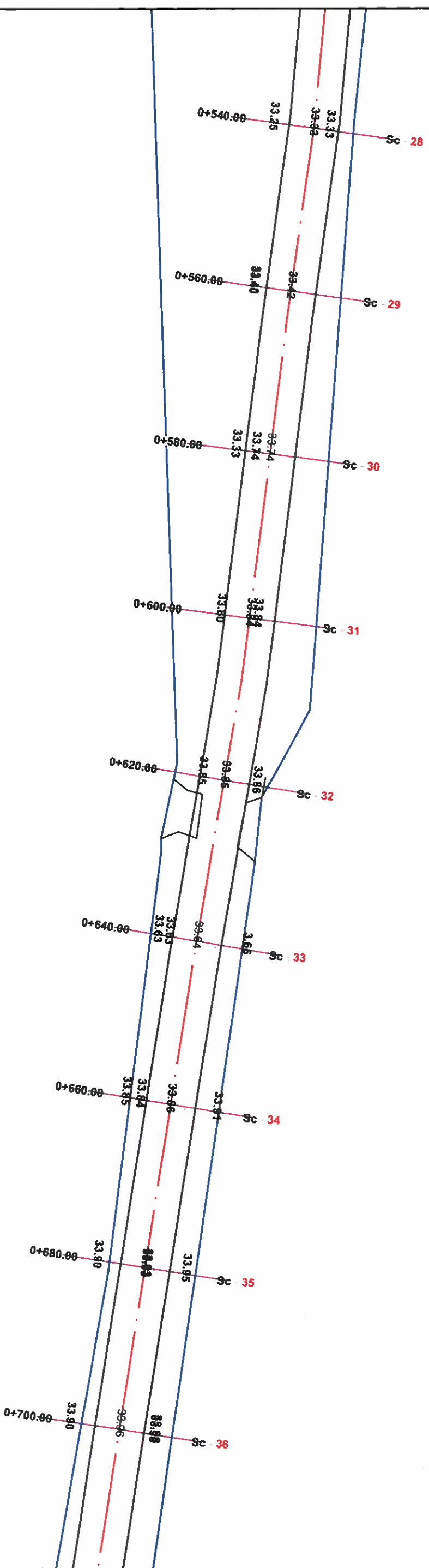

TOPOGRAFIA E RIKONSTRUKSIONIT TE SEGMENTIT TE RRUGES
 NGA QENDRA DARZEZE DERI NE BREGDET ANA PERNDIMORE SH 1:500

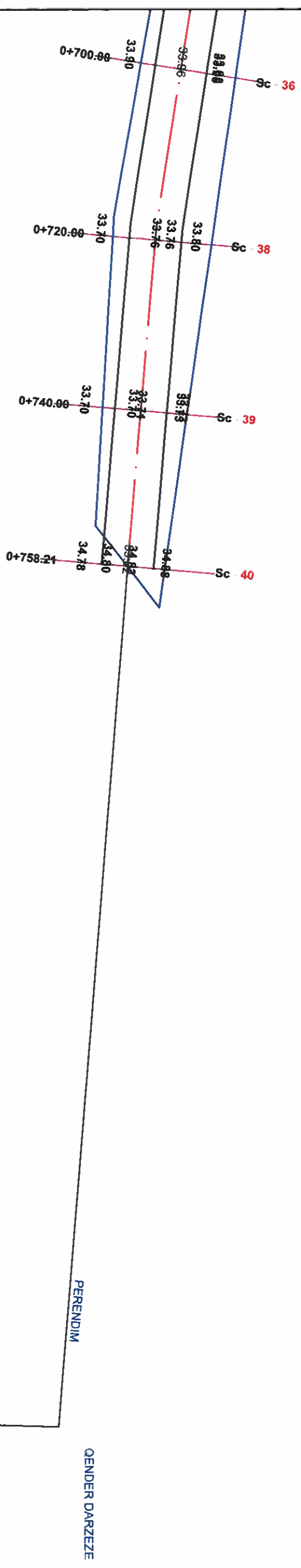

 <p>RIKONSTRUKSIONI RRUGES NGA QENDRA DARZEZE - BREGDETE(Perendim)</p>		<p>FLETA K-05</p>	
		<p>PLANIMETRIA P.K.28-36</p>	
DEPARTIMETI I PROJEKTEVE TE INFRASHTRUKTURES	Ing.	Haxhi Avdullai	
PROJ. Konstruktor	Ing.	Haxhi Avdullai	
PROJ. ARKITEKTONIK	Ark.	Erald TAVANXHIU	
TOPOGRAF	G.J.	Iisidor PRIFTI	
POROSITI	Bashkia FIER(QARKU FIER)		
			SHKURT 2025 BASHKIA FIER

TOPOGRAFIA E RIKONSTRUKSIONIT TE SEGMENTIT TE RRUGES
NGA QENDRA DARZEZE DERI NE BREGDET ANA PERENDIMORE SH 1:500



		RIKONSTRUKSIONI RRUGES NGA QENDRA DARZEZE - BREGDET(Perendim)		FLETA K-06		
DEPARTIMET E PROJEKTIMEVE TE INFRASTRUKTURES		Ing.	Haxhi Avdullai	PLANIMETRIA PIK.36-40		
Proj. Konstruktor		Ing.	Haxhi Avdullai			
Proj. ARKITEKTONIK		Ark.	Erald TAVANXHIU	SHKURT 2025 BASHKIA FIER		
TOPOGRAF		G.J.	Ilisidor PRIFTI			
POROSITI		Bashkia FIER(QARKU FIER)				



**PLANIMETRIA E RIKONSTRUKSIONIT TE SEGMENTIT TE RRUGES
NGA QENDRA DARZEZE DERI NE BREGDET NE PERENDIM SH 1:500**

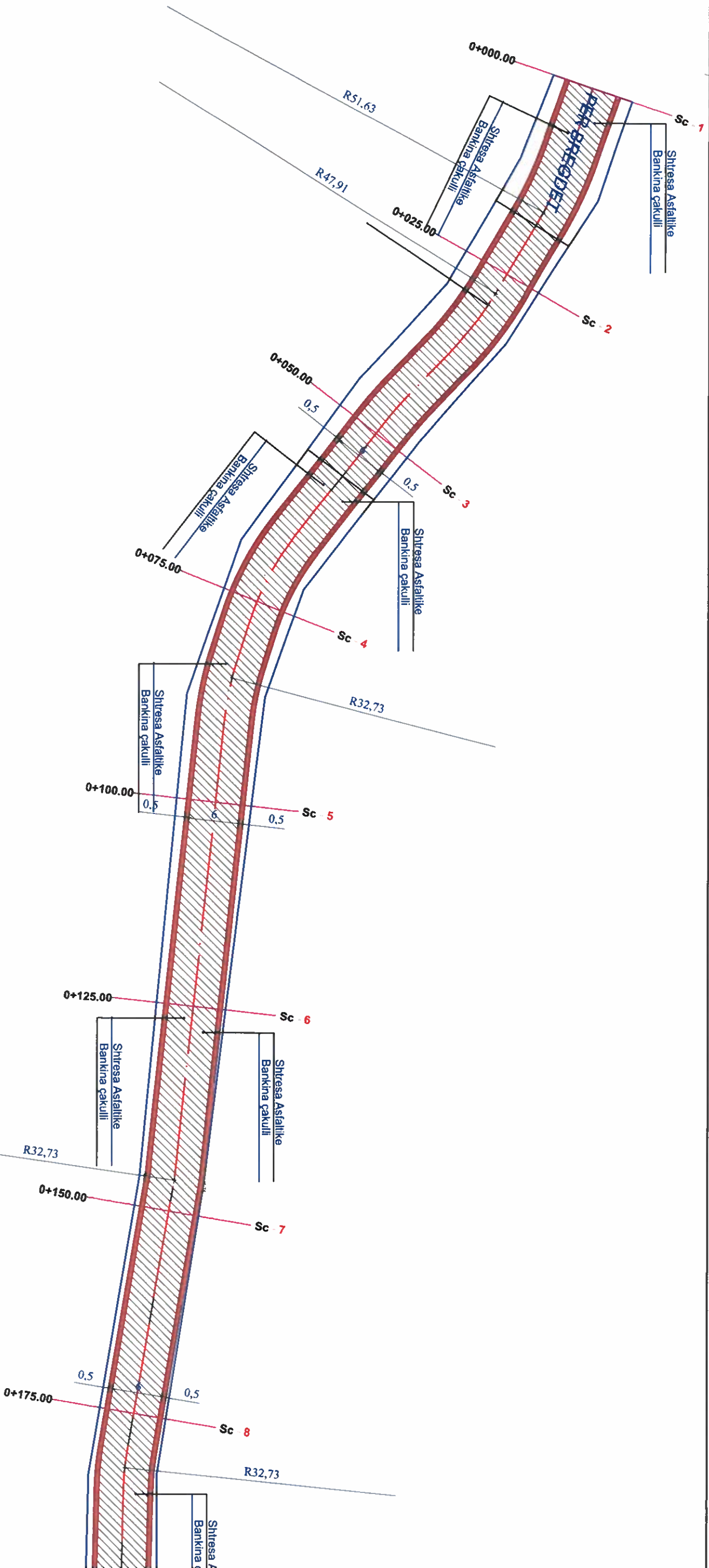

 <p>RIKONSTRUKSIONI RRUGES NGA QENDRA DARZEZE - BREGDETE(PERENDIM)</p>		<p>FLETA K-07</p>	
DR. DEDRITON BEKTESH DIREKTOR I SHKURTYRIMIT	Ing.	Haxhi Avdullai	PLANIMETRIA PIK.01-08
Proj. Konstruktor	Ing.	Haxhi Avdullai	SHKURT 2025
Proj. ARKITEKTONIK	Ark.	Erald TAVANXHIU	BASHKIA FIER
TOPOGRAFI	G.J.	Ilsidor PRIFTI	
POROSITI		Bashkia FIER(QARKU FIER)	



PLANIMETRIA E RIKONSTRUKSIONIT TE SEGMENTIT TE RRUGES
 NGA QENDRA DARZEZE DERI NE BREGDET NE PERENDIM SH 1:500

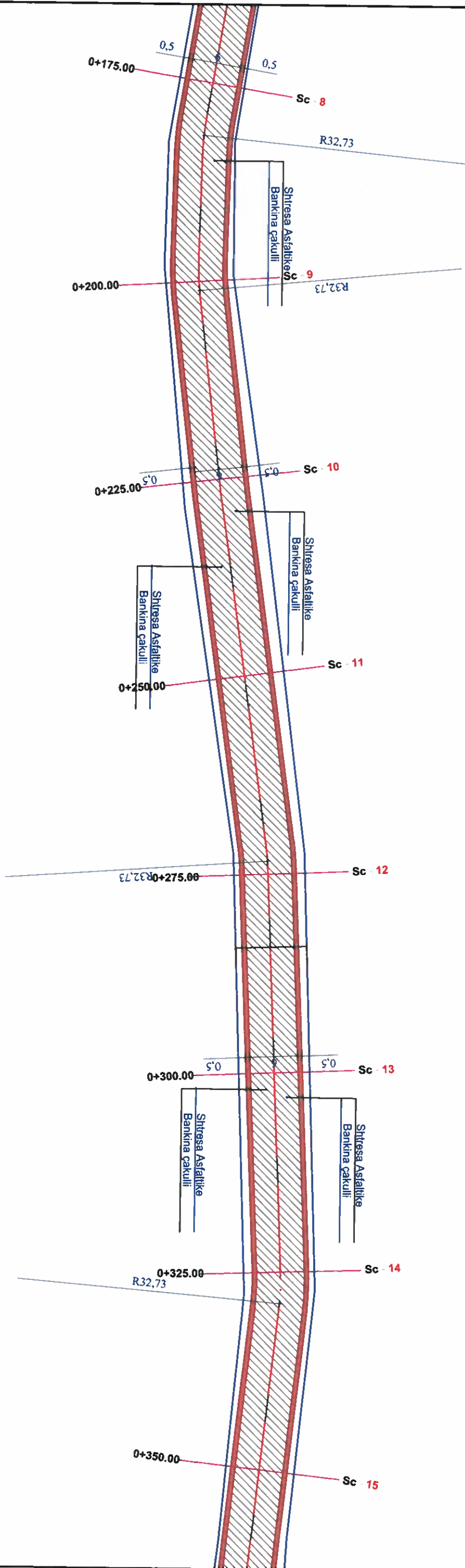

 DEPARTIMETI I INFRASTRUKTURËS DHE TRANSPORTIT		RIKONSTRUKSIONI RRUGES NGA QENDRA DARZEZE - BREGDET(PEPENDIM)		PLETA K-08
		Proj. Konstruktor Proj. Arkitektionik Topograf Porosit		
Ing. Haxhi Avdullai Ing. Haxhi Avdullai G.J. Isidor PRIFTI Bashkia FIER(QARKU FIER)		Ing. Erajd TAVANXHIU G.J.		SHKURT 2025 BASHKIA FIER



PLANIMETRIA E RIKONSTRUKSIONIT TE SEGMENTIT TE RRUGES
 NGA QENDRA DARZEZE DERI NE BREGDET NE PERENDIM SH 1:500

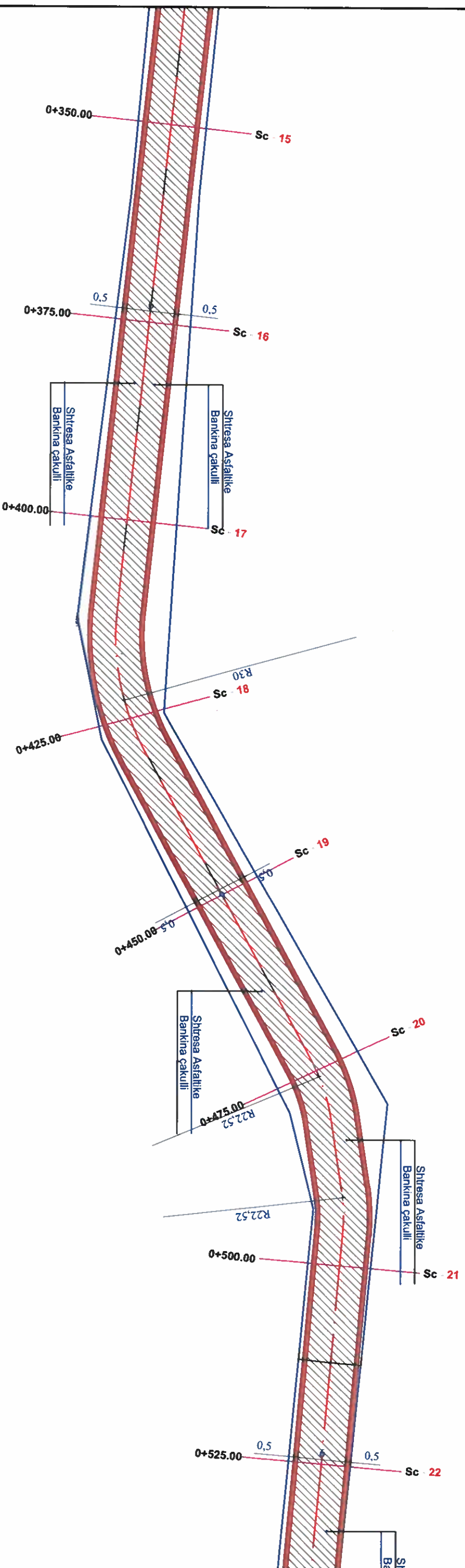

		RIKONSTRUKSIONI RRUGES NGA QENDRA DARZEZE - BREGDET(PEPENDIM)		FLETA K-09
		DR. DEDRITON SE PROJEKTEVE TE INZHINIERIUTOMES		
Proj. Konstruktor	Ing.	Haxhi Avdullai		
Proj. Arkitektonek	Atk.	Erald TAVANXHIU		
Topograf	G.J.	Ilisidor PRILETI		
Porositi	Bashkia FIER(QARKU FIER)			BASHKIA FIER





PLANIMETRIA E RIKONSTRUKSIONIT TE SEGMENTIT TE RRUGES NGA QENDRA DARZEZE DERI NE BREGDET NE PERENDIM SH 1:500

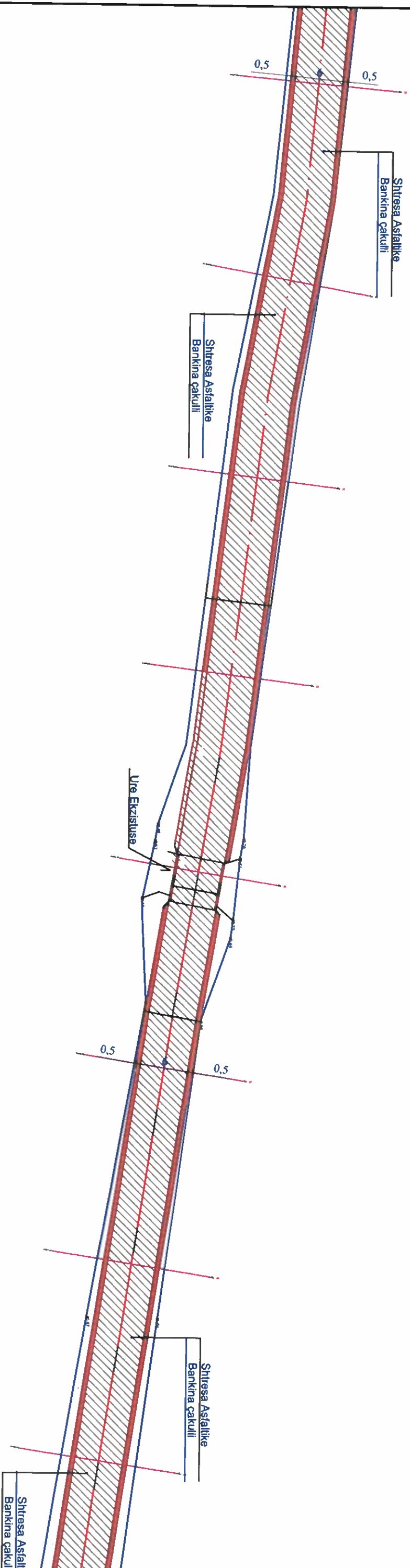

		RIKONSTRUKSIONI RRUGES NGA QENDRA DARZEZE - BREGDET(PEPENDIM)		FLETA K-10
MINISTERTI I TRANSPORTIT DHE INFRASTRUKTURËS	Ing.	Haxhi Avdullai		
Proj. Konstruktor	Ing.	Haxhi Avdullai		PLANIMETRIA PIK.22-29
Proj. ARKITEKTONIK	ARK.	Eraild TAVANXHIU		
TOPOGRAF	G.J.	Isidor PRIFTI		SHKURT 2025
POROSITI		Bashkia FIER(QARKU FIER)		BASHKIA FIER



**PLANIMETRIA E RIKONSTRUKSIONIT TE SEGMENTIT TE RRUGES
NGA QENDRA DARZEZE DERI NE BREGDET NE PERENDIM SH 1:500**

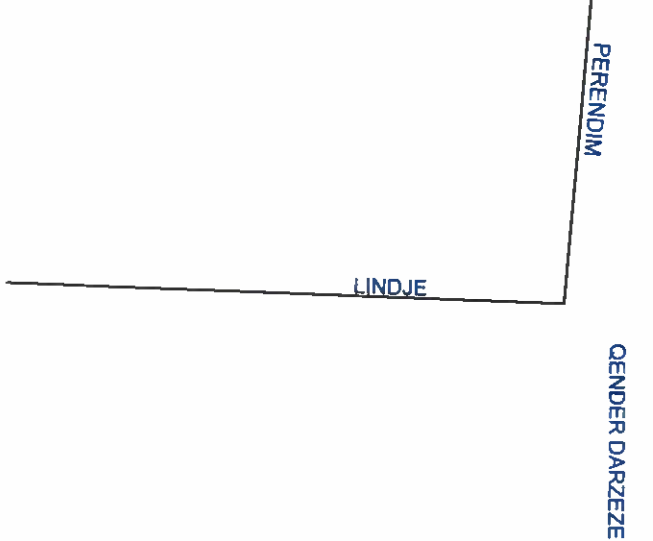
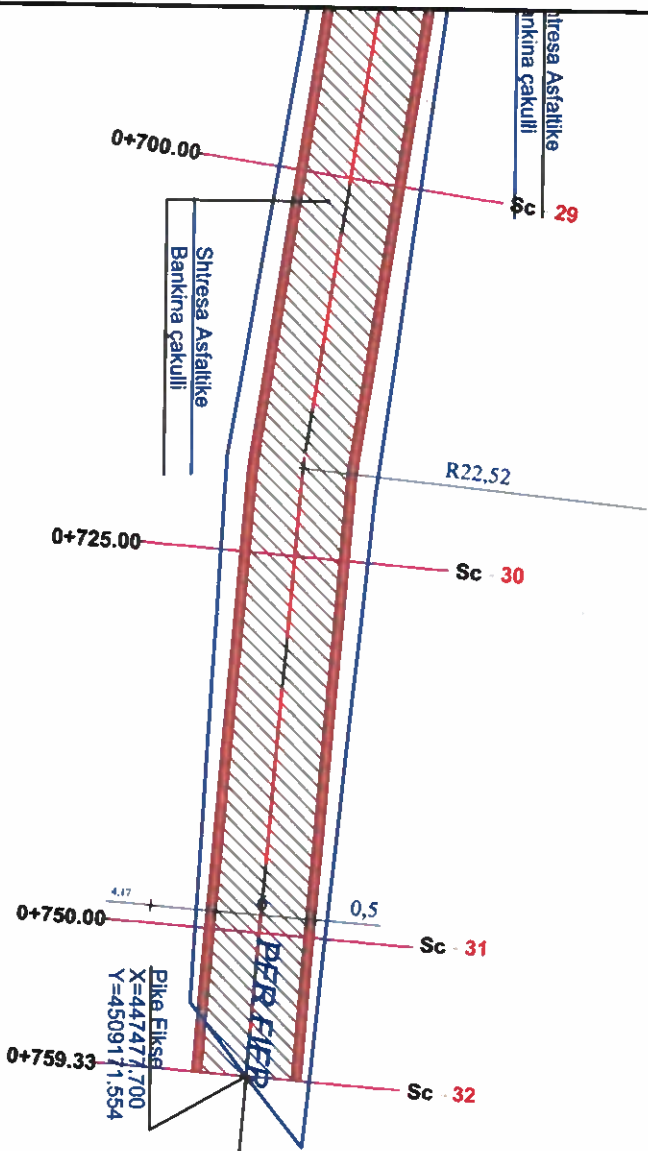

 <p align="center">RIKONSTRUKSIONI RRUGES NGA QENDRA DARZEZE - BREGDET (PERENDIM)</p>		<p align="center">FLETA K-11</p>		
		<p align="center">PLANIMETRIA PIK.28-32</p>		
<p>DI. DIBRATONIS SE PROJEKTIMEVE TE INZHINIERIENES</p>	<p>Ing.</p>	<p>Haxhi Avdullai</p>	<p>Ing.</p>	<p>Haxhi Avdullai</p>
<p>Proj. Konstruktor</p>	<p>Ark.</p>	<p>Erald TAVANXHIU</p>	<p>Ark.</p>	<p>Erald TAVANXHIU</p>
<p>PROJ. ARKITEKTONIK</p>	<p>G.J.</p>	<p>Isidor PRIFTI</p>	<p>G.J.</p>	<p>Isidor PRIFTI</p>
<p>TOPOGRAFI</p>	<p>Bashkia FIER(QARKU FIER)</p>			<p>SHKURT 2025</p>
<p>POROSITI</p>	<p>Bashkia FIER(QARKU FIER)</p>			<p>BASHKIA FIER</p>

**PROFILI TIP I RIKONSTRUKSIONIT DHE ZGJERIMIT TE SEGMENTIT TE
RRUGES QENDER DARZESE - PLAZH (PERENDIMI)
SH 1:500**

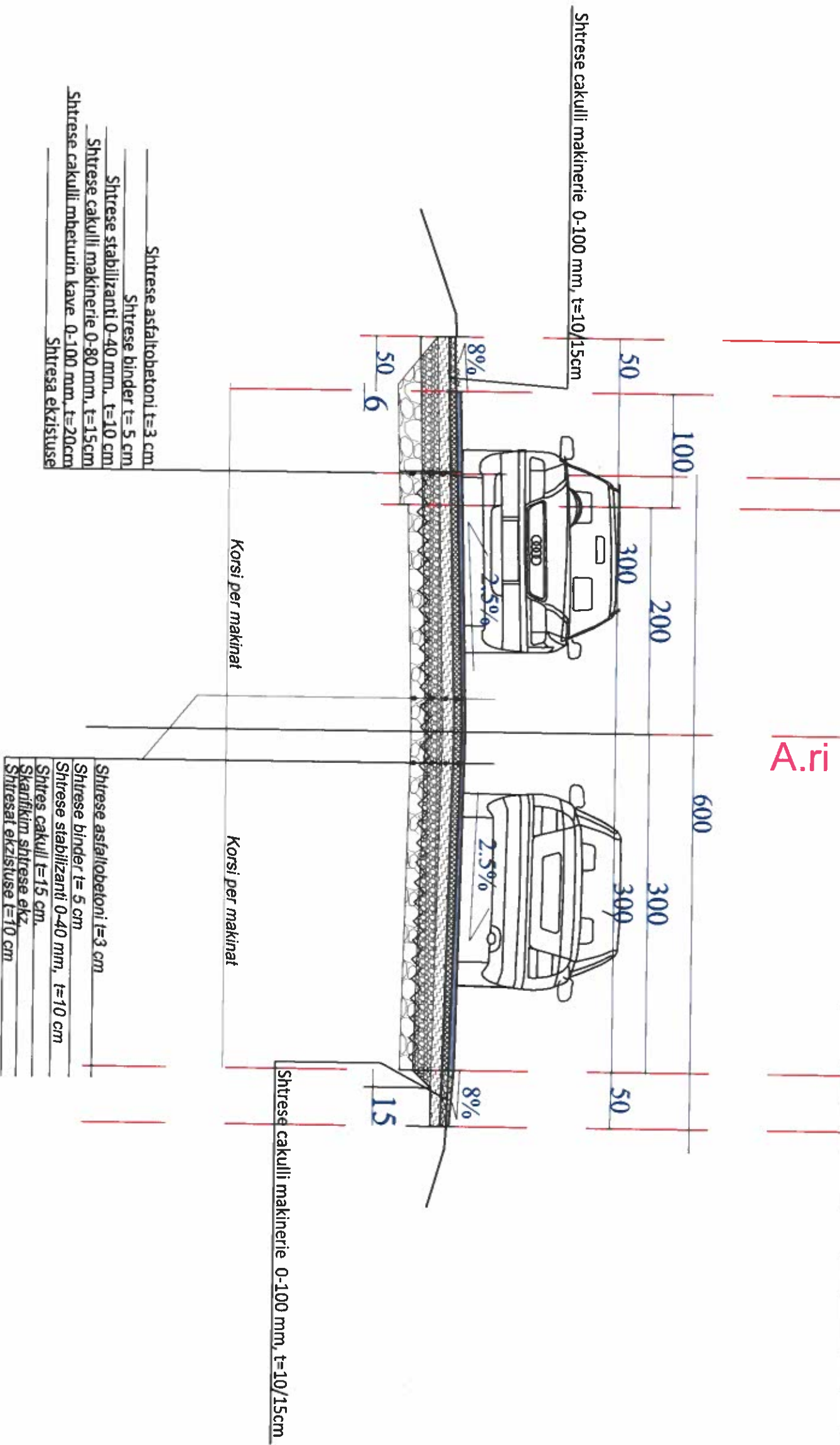

		RIKONSTRUKSIONI RRUGES NGA QENDRA DARZESE - BREGDETË (PERENDIMI)		FLETJA K-12
ORGANIZIMI I PROJEKTEVE TE INZHENIERIAVE	Ing.	Haxhi Avdullai	Ing.	PROFILI TIP I RIKONSTRUKSIONIT
PROJ. KONSTRUKTOR	Ing.	Haxhi Avdullai	Ark.	SHKURT 2025
PROJ. ARKITEKTONIK	Ark.	Erald TAVANXXHIU	G.J.	BASHKIA FIER
TOPOGRAFI	G.J.	Ilsidor PRIFTI	Bashkia FIER(QARKU FIER)	BASHKIA FIER
POROSITI				



**SINJALISTIKA E RIKONSTRUKSIONIT TE SEGMENTIT TE RRUGES
NGA QENDRA DARZEZE DERI NE BREGDET NE PERENDIM SHI 1:500**

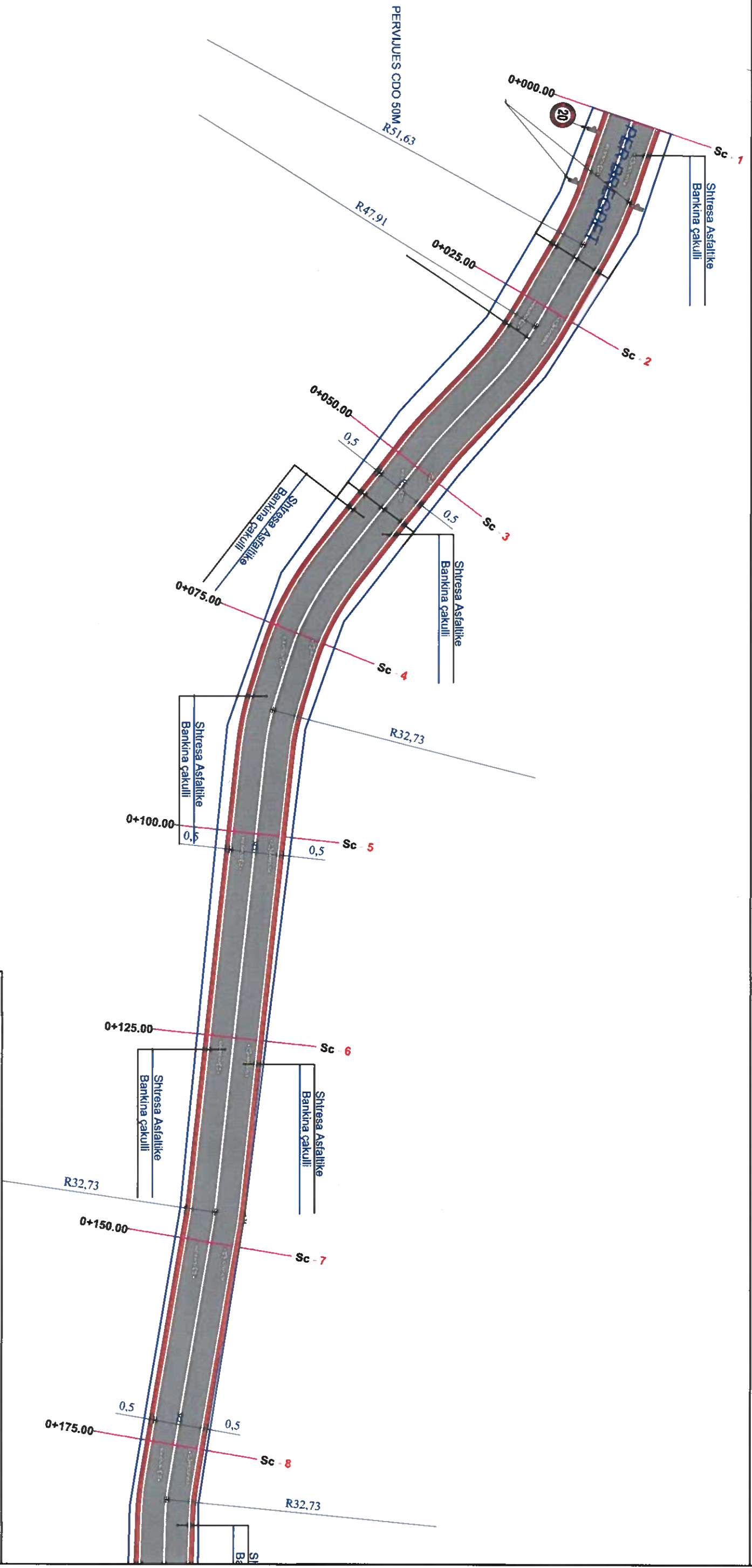

 <p>RIKONSTRUKSIONI RRUGES NGA QENDRA DARZEZE - BREGDET(PERENDIM)</p>		<p>FLETA K-13</p>
INSTITUCIONE E PROJEKTEVE TE INFRASTRUKTURES	Ing. Haxhi Avdullai	SINJALISTIKA PIK-0-08
Proj. Konstruktor	Ing. Haxhi Avdullai	
Proj. ARKITEKTONIK	Ark. Erald TAVANXHIU	SHKURT 2025 BASHKIA FIER
TOPOGRAFI	G.J. Ilisidor PRUFTI	
POROSITI	Bashkia FIER(QARKU FIER)	



SINJALISTIKA E RIKONSTRUKSIONIT TE SEGMENTIT TE RRUGES NGA QENDRA DARZEZE DERI NE BREGDET NE PERENDIM SH 1:500

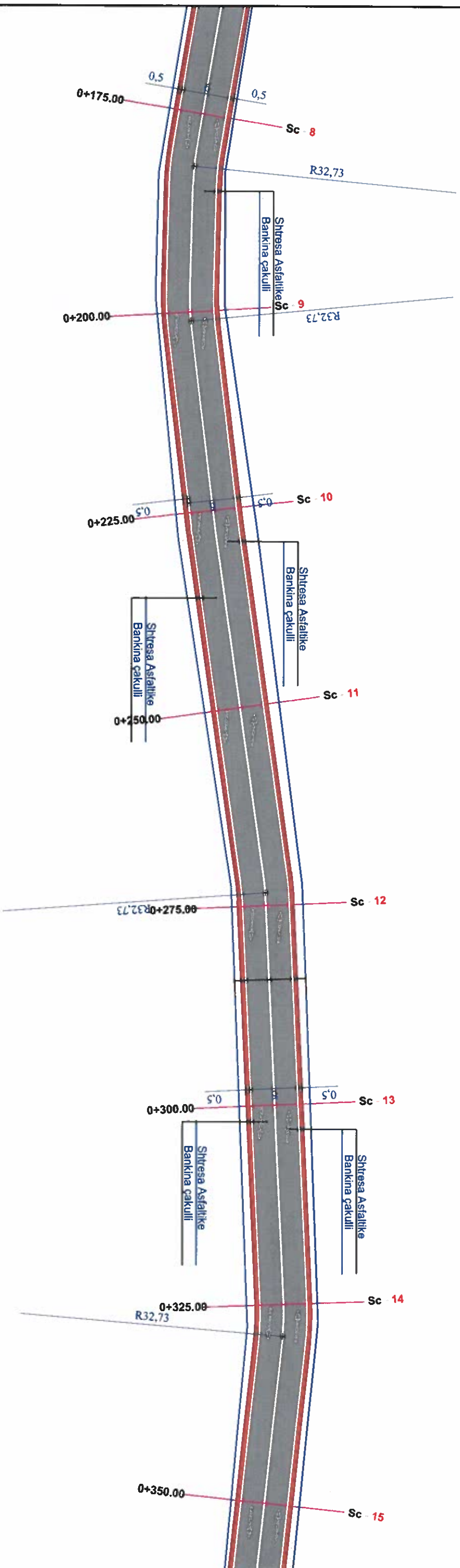



		RIKONSTRUKSIONI RRUGES NGA QENDRA DARZEZE - BREGDET(PERENDIM)		FLETA K-14
ORGANIZIMET SI PROJEKTOVETI DREKTORENTI	Ing.	Haxhi Avdullai		
Proi. Konstruktor	Ing.	Haxhi Avdullai		SINJALISTIKA PK.08 -15
Proi. ARKITEKTONIK	Ark.	Erald TAVANXHIU		
TOPOGRAFI	G.J.	Ilisidor PRUFTI		SHKURT 2025
POROSITI		Bashkia FIER(QARKU FIER)		BASHKIA FIER

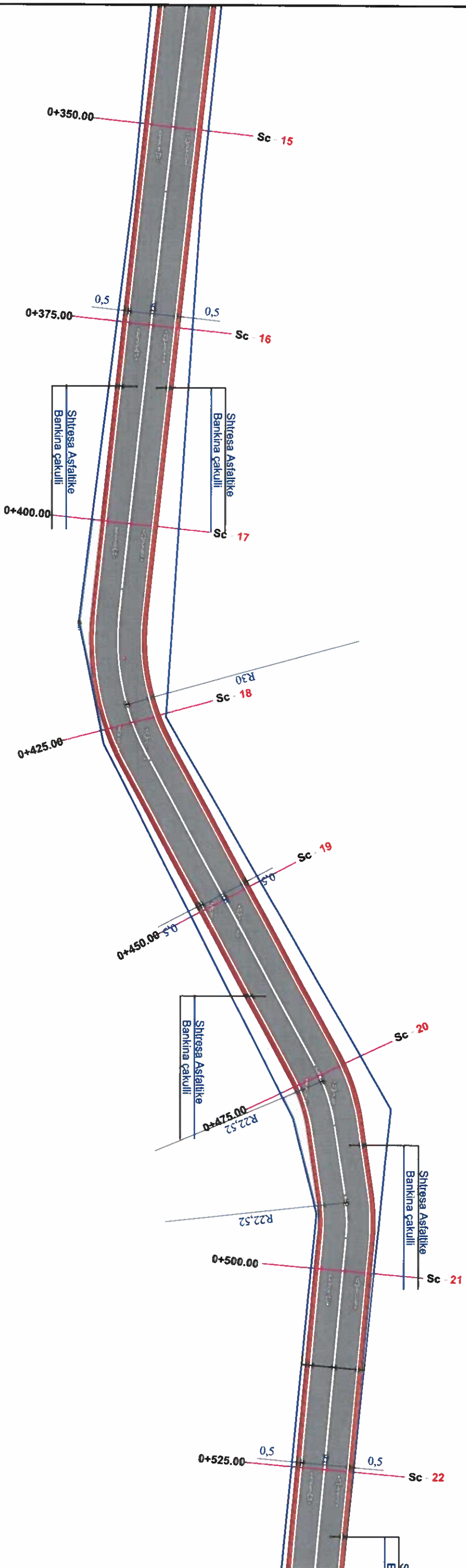

**SINJALISTIKA E RIKONSTRUKSIONIT TE SEGMENTIT TE RRUGES
NGA QENDRA DARZEZE DERI NE BREGDET NE PERENDIM SH 1:500**



 RIKONSTRUKSIONI RRUGES NGA QENDRA DARZEZE - BREGDET(PERENDIM)		FLETA K-15
DEPARTAMENTI I PROJEKTIMIT PROJEKTANTËS Proi. Konstruktor Proi. ArkitektONIK TOPOGRAFI POROSITI	Inj. Ing. Ark. G.J.	Haxhi Avdullai Haxhi Avdullai Erald TAVANXHIU Ilisidor PRLETI Bashkia FIER(QARKU FIER)
		SHKURTI 2025 BASHKIA FIER



**SINJALISTIKA E RIKONSTRUKSIONIT TE SEGMENTIT TE RRUGES
NGA QENDRA DARZEZE DERI NE BREGDET NE PERENDIM SH 1:500**

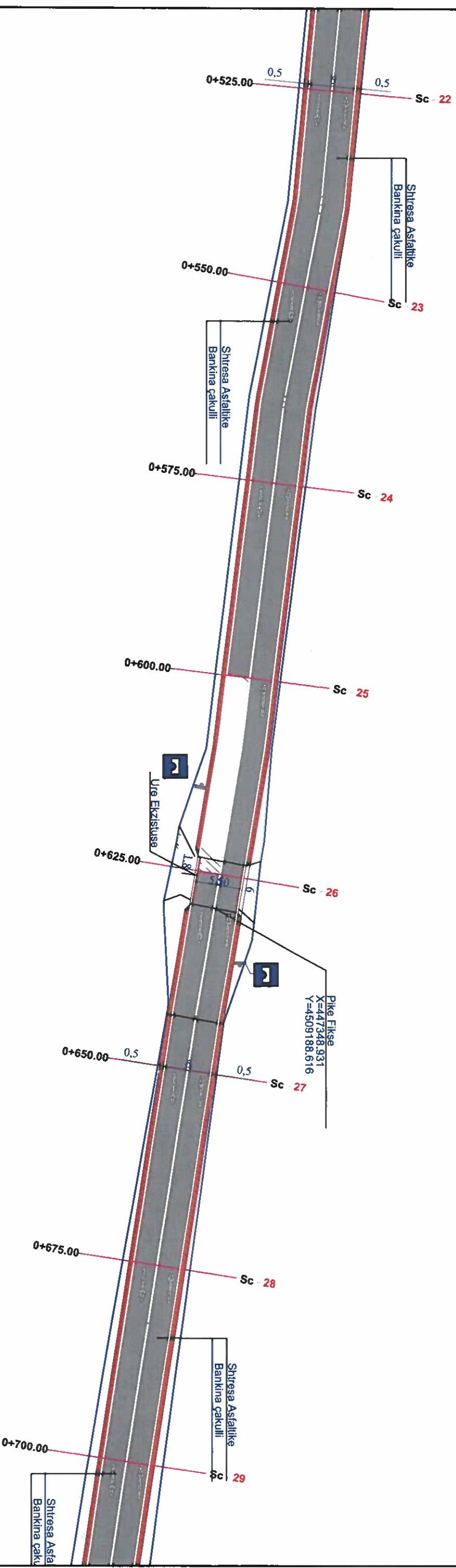

		RIKONSTRUKSIONI RRUGES NGA QENDRA DARZEZE - BREGDET(PERENDIM)		FLETA K-16
ORGANIZIMET E PROJEKTOVNEVE TE PROJEKTOVNEVE	Ing.	Haxhi Avdullai	SINJALISTIKA PIK.22 -29	
Proj. Konstruktor	Ing.	Haxhi Avdullai		
Proj. ARKITEKTONIK	Ark.	Erald TAVANXHIU		
TOKOGRAF	G.J.	Ilisidor PRUFTI	SHKURT 2025	
POROSITI		Bashkia FIER(QARKU FIER)	BASHKIA FIER	



**SINJALISTIKA E RIKONSTRUKSIONIT TE SEGMENTIT TE RRUGES
NGA QENDRA DARZEZE DERI NE BREGDET NE PERENDIM SH 1:500**

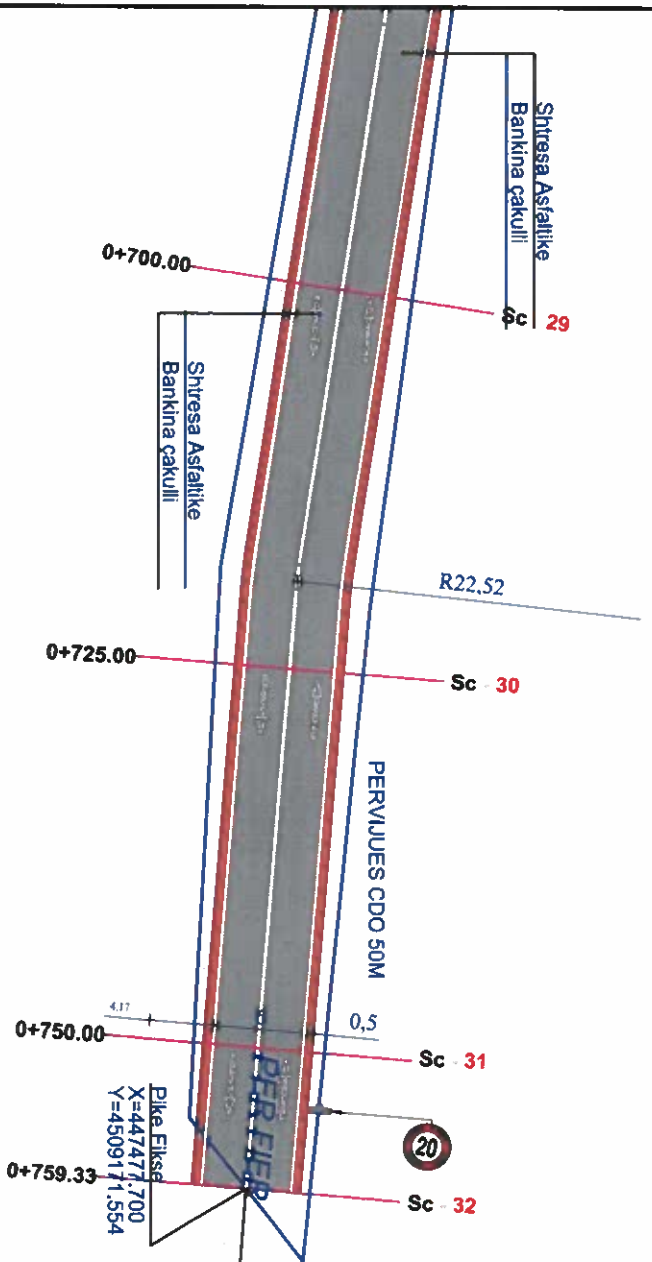

PERENDIM
QENDER DARZEZE

LINDJE

		RIKONSTRUKSIONI RRUGES NGA QENDRA DARZEZE - BREGDET(PERENDIM)		FLETA K-17
DR. PROJEKTORISSE E PROJEKTEVE TE INFRASTRUKTURES	Ing.	Haxhi Avdullai	 SHKURT 2025	SINJALISTIKA PIK.29 -32
Proj. Konstruktor	Ing.	Haxhi Avdullai		
Proj. ARKITEKTONIK	Ark.	Erald TAVANXHIU		
TOPOGRAF	GJ.	Isidor PRIFTI		
POROSITI	Bashkia FIER(QARKU FIER)			BASHKIA FIER



**PROFILI GJATSORE I RIKONSTRUKSIONIT TE SEGMENTIT TE RRUGES
NGA QENDRA DARZEZE DERI NE BREGDET (PERENDIM) SH 1:1000**

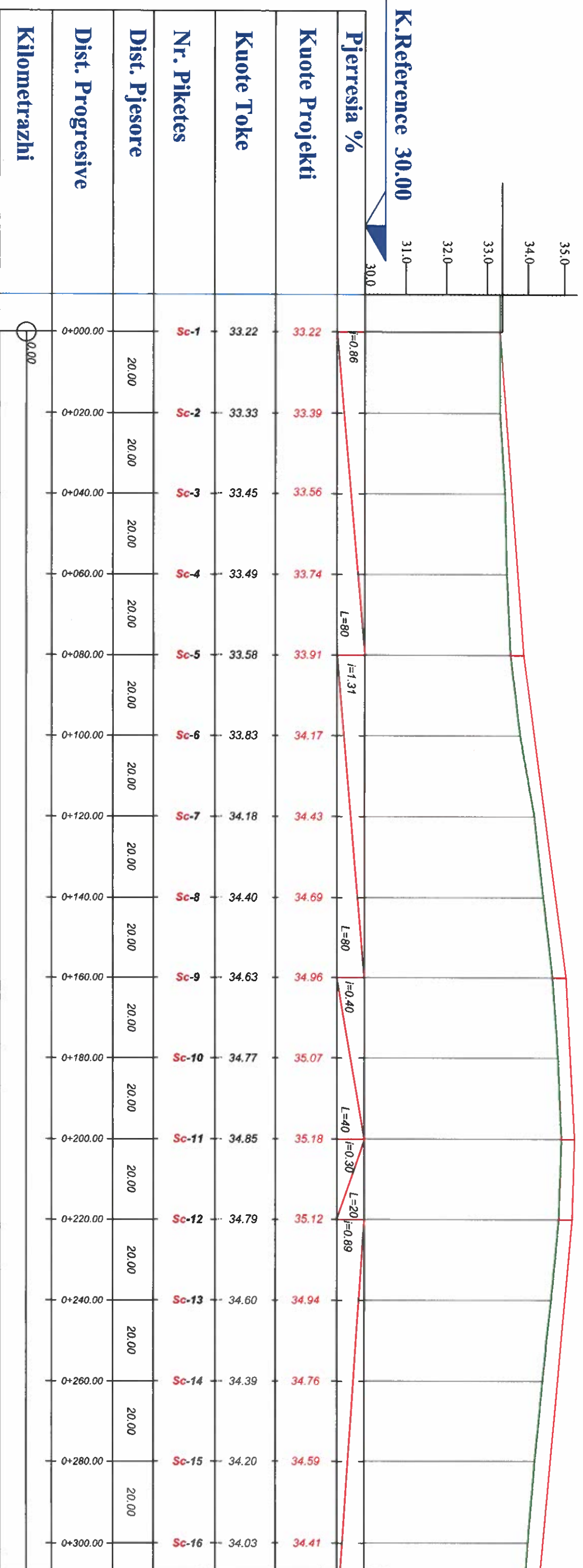

RIKONSTRUKSIONI RRUGES NGA QENDRA DARZEZE – BREGDETE(PERENDIM)		FLETA K-18	
DIREKTORISHE E PROJEKTOVIT TE INFRASTRUKTURES	Ing.	Haxhi Avdullai	
PROJ. Konstruktor	Ing.	Haxhi Avdullai	
PROJ. ARKITEKTONIK	Ark.	Erald TAVANXHIU	
TOPOGRAF	G.J.	Ilisidor PRIFTI	SHUKURT 2025
POROSITI	Bashkia FIER(QARKU FIER)		BASHKIA FIER



**PROFILI GJATSORE I RIKONSTRUKSIONIT TE SEGMENTIT TE RRUGES
NGA QENDRA DARZEZE DERI NE BREGDET (PERENDIM) SH 1:1000**

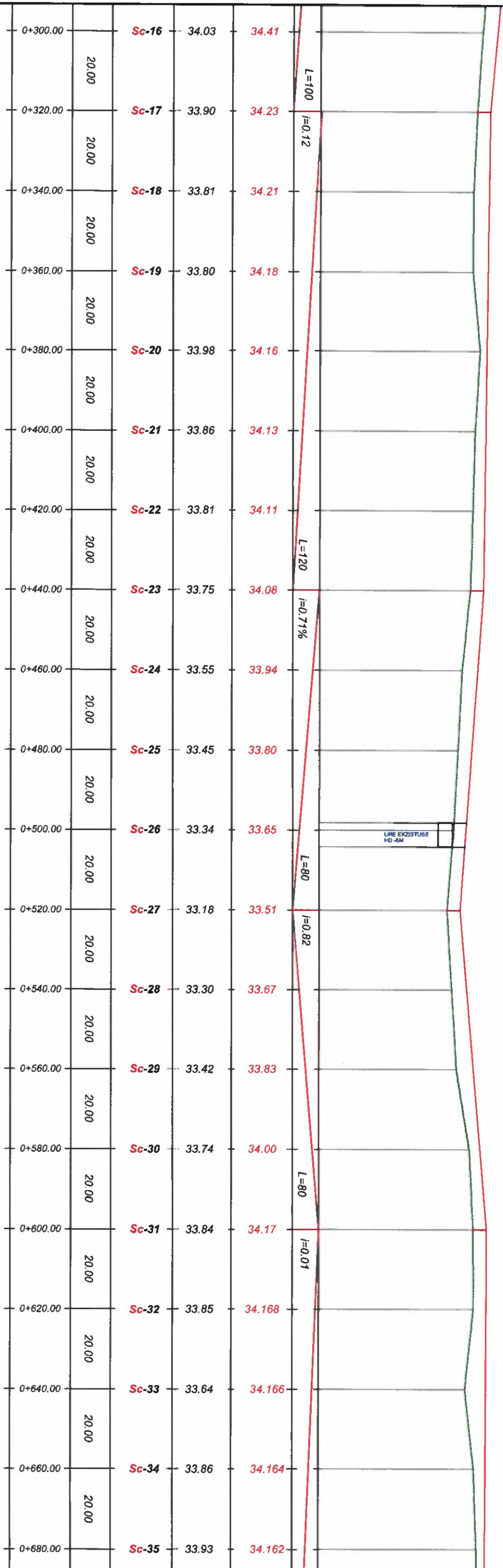

		RIKONSTRUKSIONI RRUGES NGA QENDRA DARZEZE - BREGDET(PERENDIM)		FLETA K-19
DIREKTORIBETI SHQIPTAR I INFRASTRUKTURIT	Ing.	Haxhi Avdullai	 PROFILI GJATSORE PIK.01-16	
Proj. Konstruktor	Ing.	Haxhi Avdullai		
PROJ. ARKITEKTONIK	Ark.	Enaid TAVANXHIU		
TOPOGRAF	GJ.	Isidor PRIFTI	 SHUKURT 2025	
POROSITI	Bashkia FIER(QARKU FIER)			
			BASHKIA FIER	



**PROFILI GJATSORE I RIKONSTRUKSIONIT TE SEGMENTIT TE RRUGES
NGA QENDRA DARZEZE DERI NE BREGDET (PERENDIM) SH 1:1000**

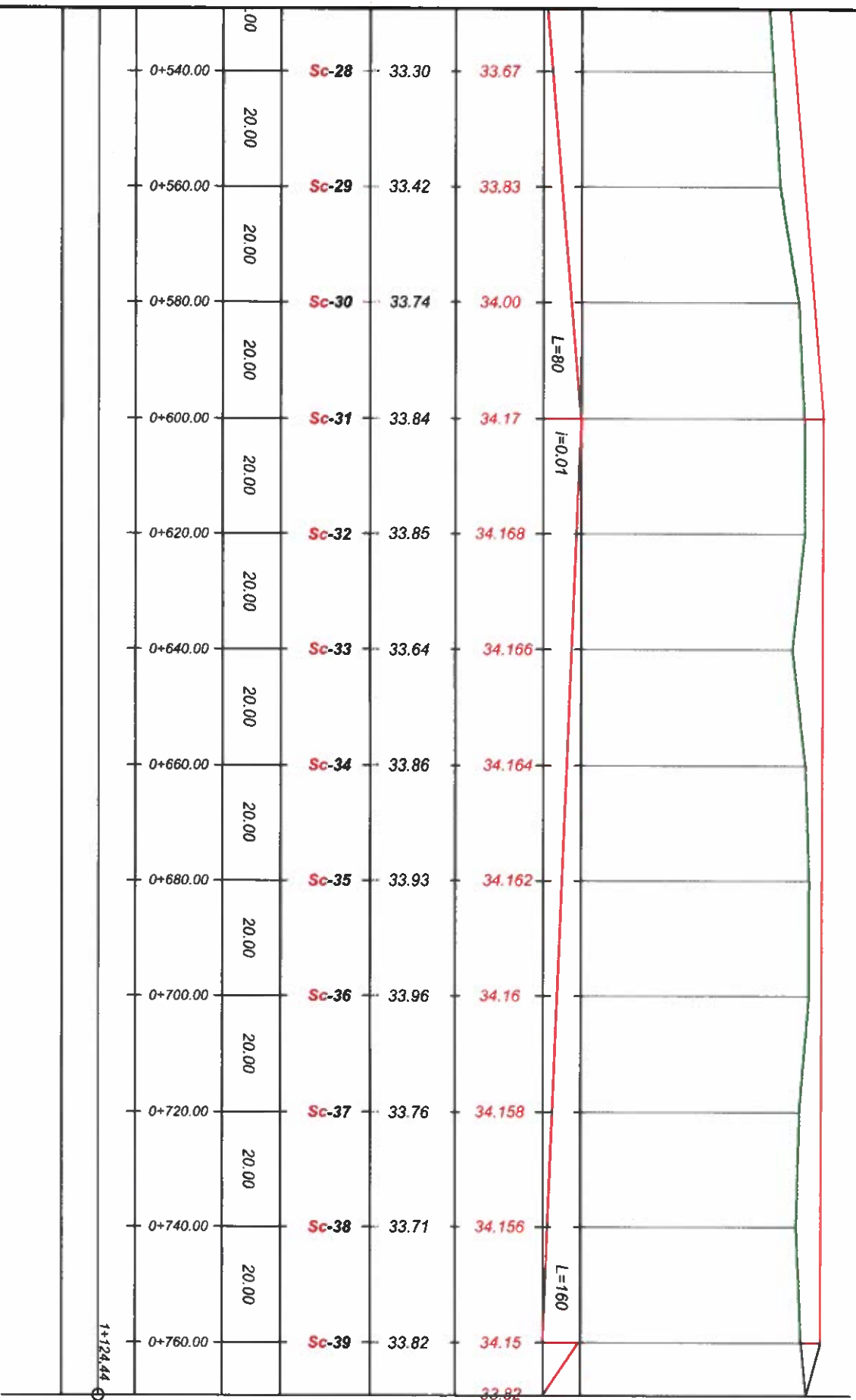

 NGA QENDRA DARZEZE - BREGDET(PERENDIM)		RIKONSTRUKSIONI RRUGES NGA QENDRA DARZEZE - BREGDET(PERENDIM)		FLETA K-20
DIREKTORINSE SI PROJEKTORE TE INFRASTRUKTURES	Ing.	Haxhi Avdullai		
Proi. Konstruktor	Ing.	Haxhi Avdullai		PROFILI GJATSOR Pik.01-16
Proi. ARKITEKTONIK	Ark.	Eraild TAVANXHIU		
Topograf	Gj.	Ilisidor PRIFTI		SHUKURT 2025
Pikositi		Bashkia FIER(QARKU FIER)		BASHKIA FIER